

STERILIZATION CONTAINER SYSTEMS

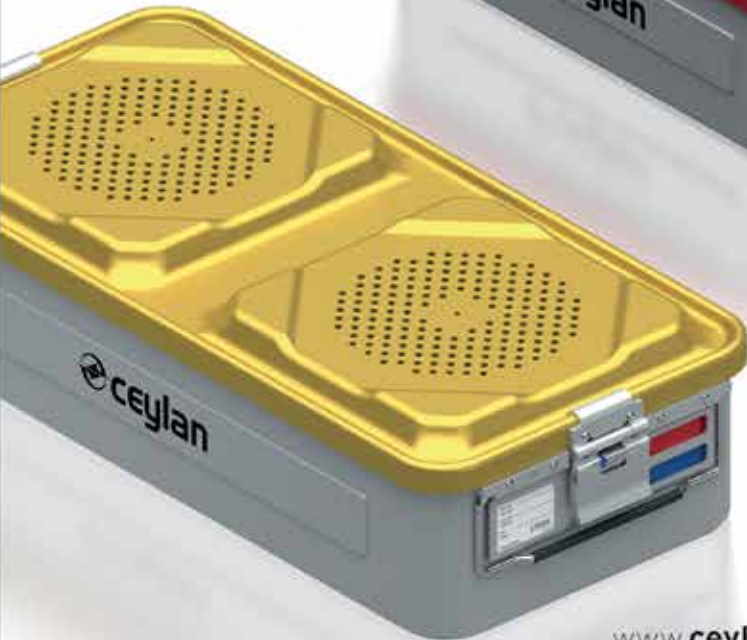

 **ceylan**

CEYLAN TIBBİ KONTEYNİR ALETLERİ MAKİNA İÇ VE DIŞ TİCARET SAN. LTD. ŞTİ.



www.ceylantibbi.com.tr



HAKKIMIZDA

Sağlık Sektörüne 2007 yılında “Ceylan” markasıyla giren kuruluşumuz, yaptığı titiz çalışmalar ile Steril Konteyner’e yeni bir anlayış ve boyut kazandırmıştır.

Uzun yıllara dayanan metal sektöründeki deneyimlerini günümüzün son sistem teknolojik makine ve ekipmanlarla birleştiren firmamız, ihtiyacı olan üretimi tamamen kendi imkanlarıyla gerçekleştirerek üretimde sıfır hatalı ürüne ulaşmıştır.

Temel ilke olarak, maksimum müşteri memnuniyetine ulaşmayı kendine prensip edinen şirketimiz, iş ortaklarımızdan aldığı geri dönüşüm bilgileriyle, kalite çitasını en üst düzeye çıkarmaktadır.

Ayrıca oluşturduğumuz deneyimli ve konularından uzman kadromuzla, ürün çeşitlerimiz artmakta, müşterilerimizin beklentiler en üst seviyelerde karşılanmaktadır.

ABOUT US

Penetrating to the Medical Instruments market, our enterprise brings a fresh approach and a new dimension to Sterile Containers concept with its exact studies.

By combining latest technology and long-time experience, our enterprise reached to perfect production level with its own sources.

Due to maximum customer satisfaction principle, our company raises the quality to the highest level with feedbacks of our business partners.

Furthermore, we improve our product variety and provide the best service possible to fulfill our customers’ expectations with our well-experienced and highly educated staff.

Contents

Sterilization Container Systems

1 - 9 Introductory

10 - 33 Edition Plus Series

- 10 - 15 Standard Filter System
- 16 - 21 Barrier Valve Filter System
- 22 - 27 Safe Guardian System
- 28 - 33 Dismountable Barrier Filter System

34 - 63 Master Series

- 34 - 39 Standard Filter System
- 40 - 45 Suede Channel Filter
- 46 - 51 Barrier Valve Filter System
- 52 - 57 Safe Guardian System
- 58 - 63 Dismountable Barrier Filter System

64 Implant Containers

65 Scopy Containers

66 Anodized Sheet Metal Baskets

67 Orthopaedic Trays

68 - 69 Dental Containers

- 68 Standard Filter System
- 69 Barrier Filter System

70 - 71 Mini Containers

- 70 Standard Filter System
- 71 Barrier Filter System

72 Endoscopy Containers

73 Mini Containers / New Model

74 - 75 Wire Baskets

76 - 77 Stainless Steel Baskets

78 General Accessories

79 Stenter / Base / Divider

SERTİFİKALARIMIZ



WHY SHOULD I USE STERILIZATION CONTAINER SYSTEMS?

Time and technology are developing one more step at a time. This improving effects of sterilization systems affect every field of life. As you know, there are two ways to of sterilization of surgical instruments.

- ▶ Sterilization Containers
- ▶ Disposable Textile Wraps

In contrast to the single-used old-fashion sterilization systems, the new style of sterilization systems reduce waste and the cost of our expenses. As you know, there are two ways to sterilization of surgical instruments. The most important difference between these methods is security.

Disposable textile wraps, arouse during or after the autoclave process, may arouse negative situations like reopening or tearing of these wraps. This negative situation will also cause the loss of sterilization of surgical equipment. Therefore, one will never be sure about the sterilization of materials %100.

Nevertheless, sterilization containers are produced by using high quality of 2mm aluminum and, at the same time, they completely cut off their touch with the world by using silicone sealing gaskets inside the lid and around the filter system, and completely perform sterilization during the autoclaving process.

Unlike the single-used wraps, container sterilization systems provide maximum sterilization and have a storage and shelf life of 6 months if the lid of the container is not opened after the process.

Additionally, single used wraps arouse waste of bandages and, regardless of the world environmental situation, it is not good for the earth.

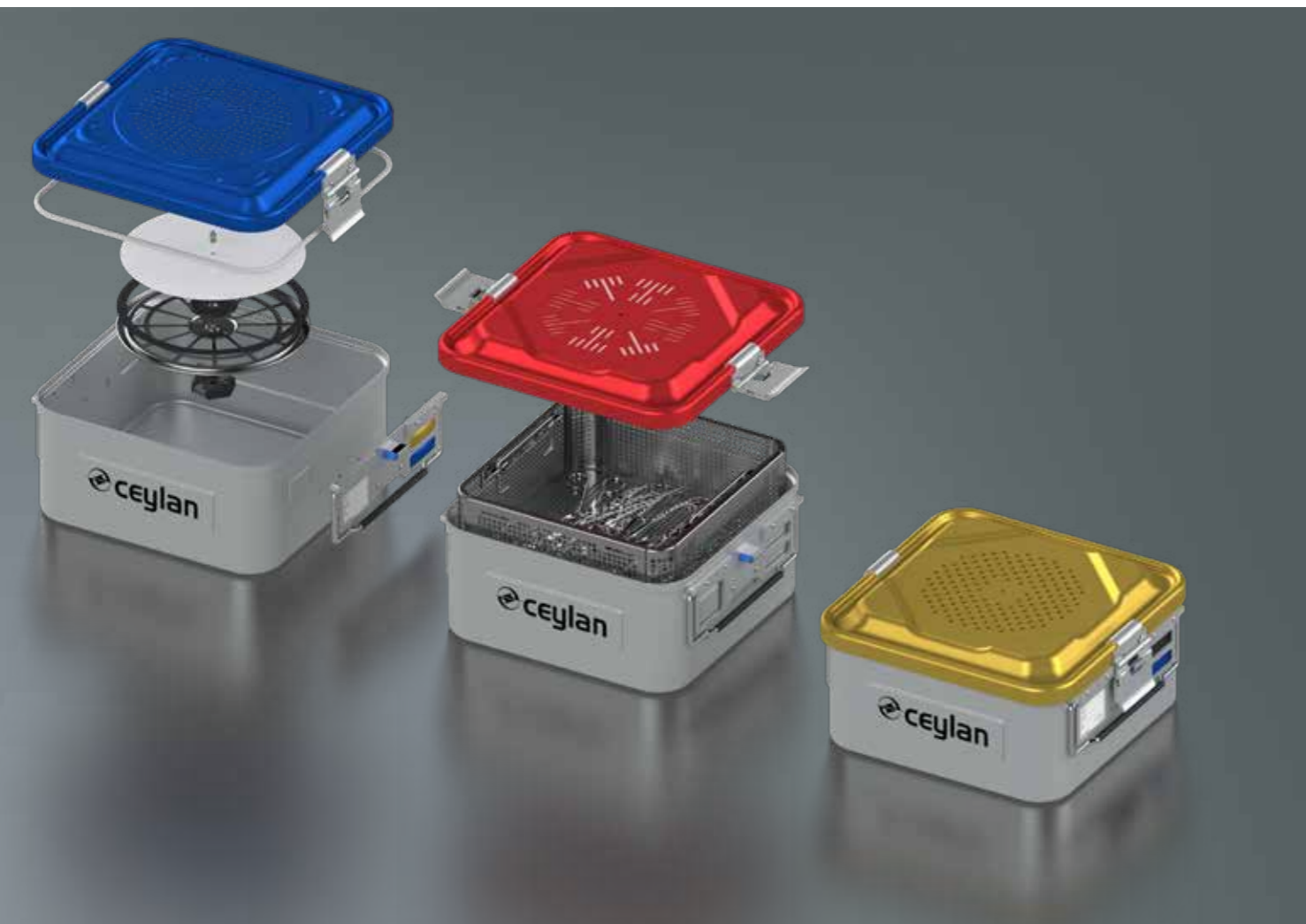

THE PROCESS OF STERILIZATION CONTAINER PRODUCTION



PRODUCTION

Subsequently CNC machining, press molds, anodized coatings and polishing techniques, they are sent to control assembly line by the fully automatic laser quality control systems.



ASSEMBLY

Sterilization containers are consist of 78 different parts in total, all parts are assembled on the assembly line.



QUALITY

After the final controls of the assembly, the quality control is done for the container defect, and the water proofness test is carried out and sent to the packaging line.



PACKAGING

When the sterilization containers are ready for departure to the final user ,it packaging with the protection from the outside damages and defections.

DEVELOPED FILTER SYSTEMS

DISMOUNTABLE BARRIER SYSTEM



Ceylan has rediscovered in front of view the inducement of its customers, this filter system, which is produced entirely from anodized and aluminum materials, catches bacteria in its channel lines thanks to the intrusion and protrusion on it. It prevents bacteria from reaching into the container and since the filter system is removed, the channels intrusions are cleaned before each sterilization. It does not require the use of filter like standard filter systems.

BARRIER CONTAINER SYSTEM



This product, which is patented by the Ceylan Medical brand, is both user-friendly and economical in the long term since, the barrier system does not require the use of filters. The valve system it contains opens during sterilization and takes 134 degrees of steam into it. After the sterilization process is finished, it is vacuumed by the autoclave and the valve closes and isolates the surgical instruments inside from bacteria in the external environment.

STANDARD FILTER SYSTEM



Standard filter system producing by 304 quality stainless chromium. According to users preference, papers and textile filters are usable options. Initially, the paper filter is single-use and it requires changing before the each sterilization process. Unlike the paper filter, textile and teflon filters have a longer life than the paper filters. When a textile filter can sterilize 100 times, a teflon filter can perform 1000 times sterilization. The filter, which will be installed before sterilization, will be purified from materials that can reach to the containers after sterilization.



Ceylan Medical encounters all demands quite meticulously by one of its various filter systems which bottom and up filter system.



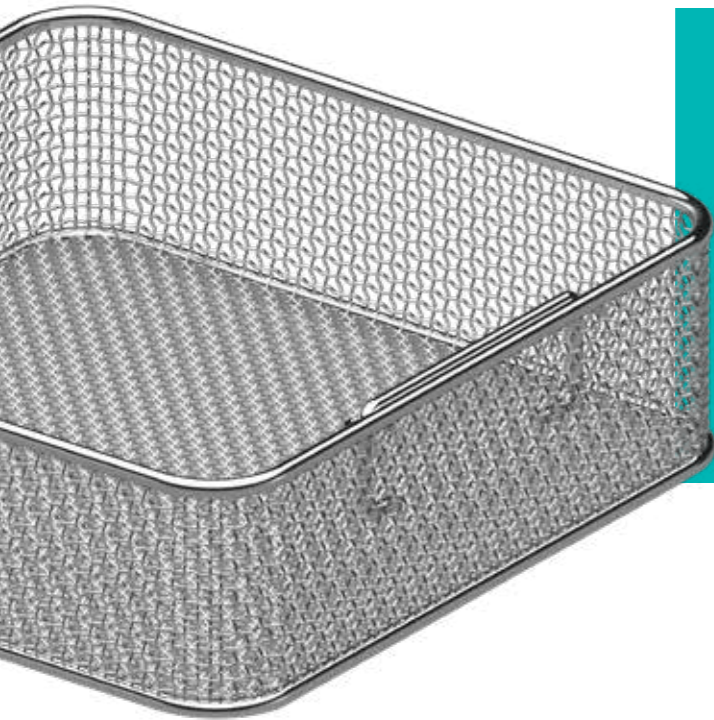

Ceylan Medical
has become one of the leading names in the sector with its various dimensions and improved filter systems.

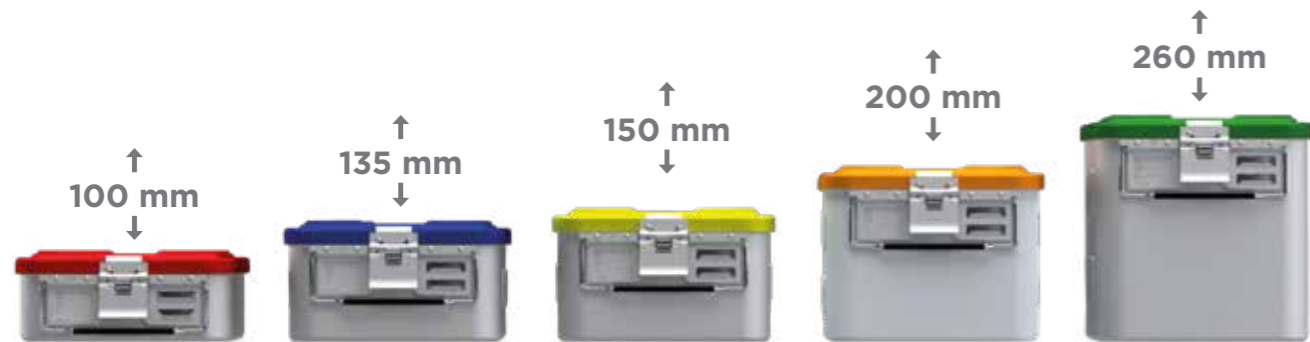

Edition Plus Series Sterilization Container Systems



Standard Filter System



Bottom Non Perforated

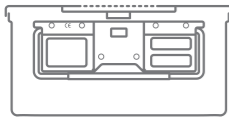

285x280x100mm 2190gr.	285x280x135mm 2240gr.	285x280x150mm 2320gr.	285x280x200mm 2475gr.	285x280x260mm 2630gr.
■ CKK-10-001	■ CKK-13-001	■ CKK-15-001	■ CKK-20-001	■ CKK-26-001
■ CKK-10-002	■ CKK-13-002	■ CKK-15-002	■ CKK-20-002	■ CKK-26-002
■ CKK-10-003	■ CKK-13-003	■ CKK-15-003	■ CKK-20-003	■ CKK-26-003
■ CKK-10-004	■ CKK-13-004	■ CKK-15-004	■ CKK-20-004	■ CKK-26-004
■ CKK-10-005	■ CKK-13-005	■ CKK-15-005	■ CKK-20-005	■ CKK-26-005
■ CKK-10-006	■ CKK-13-006	■ CKK-15-006	■ CKK-20-006	■ CKK-26-006
■ CKK-10-007	■ CKK-13-007	■ CKK-15-007	■ CKK-20-007	■ CKK-26-007

Bottom Perforated

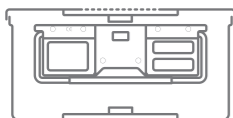

285x280x100mm 2290gr.	285x280x135mm 2340gr.	285x280x150mm 2425gr.	285x280x200mm 2615gr.	285x280x260mm 2730gr.
■ CKK-10-011	■ CKK-13-011	■ CKK-15-011	■ CKK-20-011	■ CKK-26-011
■ CKK-10-012	■ CKK-13-012	■ CKK-15-012	■ CKK-20-012	■ CKK-26-012
■ CKK-10-013	■ CKK-13-013	■ CKK-15-013	■ CKK-20-013	■ CKK-26-013
■ CKK-10-014	■ CKK-13-014	■ CKK-15-014	■ CKK-20-014	■ CKK-26-014
■ CKK-10-015	■ CKK-13-015	■ CKK-15-015	■ CKK-20-015	■ CKK-26-015
■ CKK-10-016	■ CKK-13-016	■ CKK-15-016	■ CKK-20-016	■ CKK-26-016
■ CKK-10-017	■ CKK-13-017	■ CKK-15-017	■ CKK-20-017	■ CKK-26-017

1/2 Half Size - Küçük Boy



Filter Holder Lid / Filtre Tutuculu Kapak

285x280mm
830gr.

■ CKK-K-011
■ CKK-K-012
■ CKK-K-013
■ CKK-K-014
■ CKK-K-015
■ CKK-K-016
■ CKK-K-017

285x280mm
670gr.

■ CKK-K-001
■ CKK-K-002
■ CKK-K-003
■ CKK-K-004
■ CKK-K-005
■ CKK-K-006
■ CKK-K-007

Non Filter Holder Lid / Filtre Tutucusuz Kapak



Bottom Perforated
Altan Delikli Konteyner

Code	Dimension	Weight
CKK-10-01	285x280x100mm	1460gr.
CKK-13-01	285x280x135mm	1510gr.
CKK-15-01	285x280x150mm	1595gr.
CKK-20-01	285x280x200mm	1785gr.
CKK-26-01	285x280x260mm	1920gr.



Bottom Perforated
Altan Deliksiz Konteyner

Code	Dimension	Weight
CKK-10-00	285x280x100mm	1360gr.
CKK-13-00	285x280x135mm	1410gr.
CKK-15-00	285x280x150mm	1490gr.
CKK-20-00	285x280x200mm	1645gr.
CKK-26-00	285x280x260mm	1800gr.

Edition Plus Series Sterilization Container Systems



Standard Filter System



3/4 Middle Size - Orta Boy

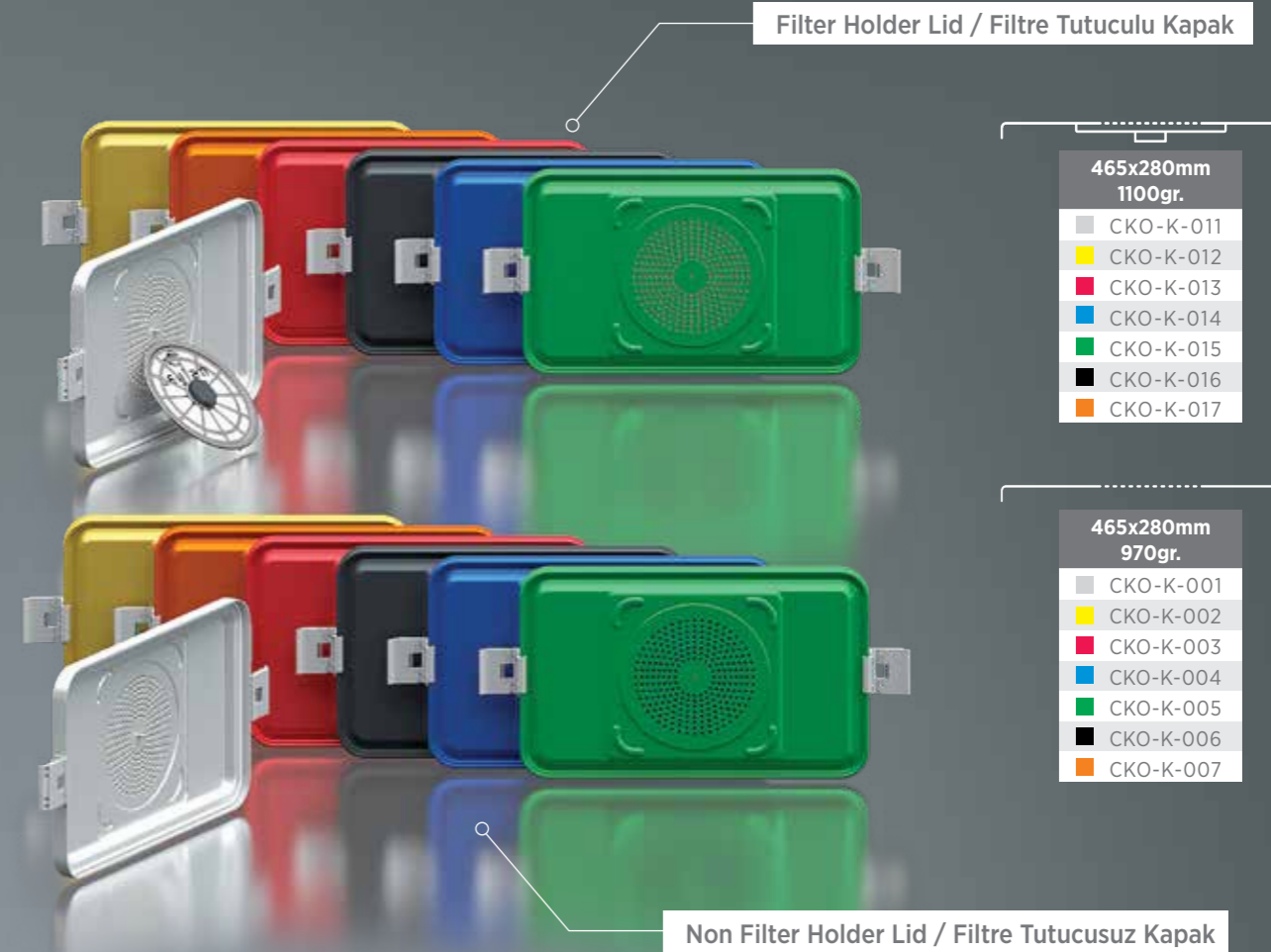

465x280mm
1100gr.

█	CKO-K-011
█	CKO-K-012
█	CKO-K-013
█	CKO-K-014
█	CKO-K-015
█	CKO-K-016
█	CKO-K-017

465x280mm
970gr.

█	CKO-K-001
█	CKO-K-002
█	CKO-K-003
█	CKO-K-004
█	CKO-K-005
█	CKO-K-006
█	CKO-K-007



Bottom Perforated
Altan Delikli Konteyner

Code	Dimension	Weight
CKO-10-01	465x280x100mm	1700gr.
CKO-13-01	465x280x135mm	1850gr.
CKO-15-01	465x280x150mm	1950gr.
CKO-20-01	465x280x200mm	2100gr.



Bottom Non Perforated
Altan Deliksiz Konteyner

Code	Dimension	Weight
CKO-10-00	465x280x100mm	1550gr.
CKO-13-00	465x280x135mm	1700gr.
CKO-15-00	465x280x150mm	1800gr.
CKO-20-00	465x280x200mm	1950gr.

Bottom Non Perforated

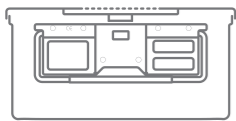

465x280x100mm
2650gr.

█	CKO-10-001
█	CKO-10-002
█	CKO-10-003
█	CKO-10-004
█	CKO-10-005
█	CKO-10-006
█	CKO-10-007

465x280x135mm
2800gr.

█	CKO-13-001
█	CKO-13-002
█	CKO-13-003
█	CKO-13-004
█	CKO-13-005
█	CKO-13-006
█	CKO-13-007

465x280x150mm
2900 gr.

█	CKO-15-001
█	CKO-15-002
█	CKO-15-003
█	CKO-15-004
█	CKO-15-005
█	CKO-15-006
█	CKO-15-007

465x280x200mm
3050gr.

█	CKO-20-001
█	CKO-20-002
█	CKO-20-003
█	CKO-20-004
█	CKO-20-005
█	CKO-20-006
█	CKO-20-007

Bottom Perforated



465x280x100mm
2800gr.

█	CKO-10-011
█	CKO-10-012
█	CKO-10-013
█	CKO-10-014
█	CKO-10-015
█	CKO-10-016
█	CKO-10-017

465x280x135mm
2950gr.

█	CKO-13-011
█	CKO-13-012
█	CKO-13-013
█	CKO-13-014
█	CKO-13-015
█	CKO-13-016
█	CKO-13-017

465x280x150mm
3050gr.

█	CKO-15-011
█	CKO-15-012
█	CKO-15-013
█	CKO-15-014
█	CKO-15-015
█	CKO-15-016
█	CKO-15-017

465x280x200mm
3200gr.

█	CKO-20-011
█	CKO-20-012
█	CKO-20-013
█	CKO-20-014
█	CKO-20-015
█	CKO-20-016
█	CKO-20-017

Edition Plus Series Sterilization Container Systems



Standard Filter System



Bottom Non Perforated

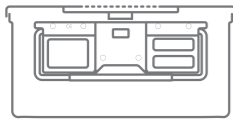

580x280x100mm 3300gr.	580x280x135mm 3600gr	580x280x150mm 3800gr	580x280x200mm 4160gr.	580x280x260mm 4500gr.
■ CKB-10-001	■ CKB-13-001	■ CKB-15-001	■ CKB-20-001	■ CKB-26-001
■ CKB-10-002	■ CKB-13-002	■ CKB-15-002	■ CKB-20-002	■ CKB-26-002
■ CKB-10-003	■ CKB-13-003	■ CKB-15-003	■ CKB-20-003	■ CKB-26-003
■ CKB-10-004	■ CKB-13-004	■ CKB-15-004	■ CKB-20-004	■ CKB-26-004
■ CKB-10-005	■ CKB-13-005	■ CKB-15-005	■ CKB-20-005	■ CKB-26-005
■ CKB-10-006	■ CKB-13-006	■ CKB-15-006	■ CKB-20-006	■ CKB-26-006
■ CKB-10-007	■ CKB-13-007	■ CKB-15-007	■ CKB-20-007	■ CKB-26-007

Bottom Perforated

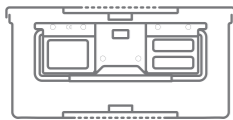

580x280x100mm 3400gr.	580x280x135mm 3920gr.	580x280x150mm 4000gr.	580x280x200mm 4260gr.	580x280x260mm 4600gr.
■ CKB-10-011	■ CKB-13-011	■ CKB-15-011	■ CKB-20-011	■ CKB-26-011
■ CKB-10-012	■ CKB-13-012	■ CKB-15-012	■ CKB-20-012	■ CKB-26-012
■ CKB-10-013	■ CKB-13-013	■ CKB-15-013	■ CKB-20-013	■ CKB-26-013
■ CKB-10-014	■ CKB-13-014	■ CKB-15-014	■ CKB-20-014	■ CKB-26-014
■ CKB-10-015	■ CKB-13-015	■ CKB-15-015	■ CKB-20-015	■ CKB-26-015
■ CKB-10-016	■ CKB-13-016	■ CKB-15-016	■ CKB-20-016	■ CKB-26-016
■ CKB-10-017	■ CKB-13-017	■ CKB-15-017	■ CKB-20-017	■ CKB-26-017

1/1 Full Size - Büyük Boy

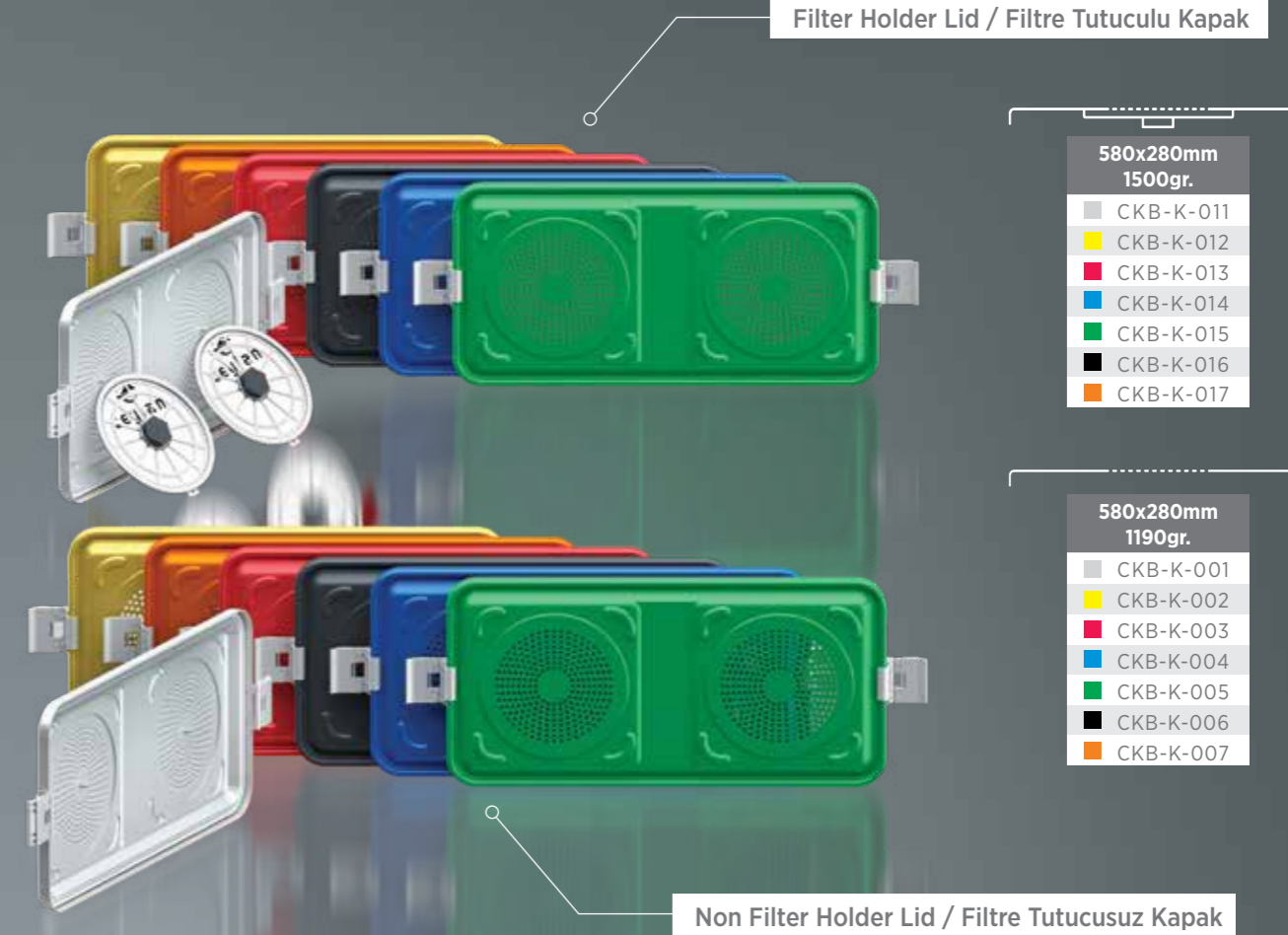

580x280mm
1500gr.

■ CKB-K-011
■ CKB-K-012
■ CKB-K-013
■ CKB-K-014
■ CKB-K-015
■ CKB-K-016
■ CKB-K-017

580x280mm
1190gr.

■ CKB-K-001
■ CKB-K-002
■ CKB-K-003
■ CKB-K-004
■ CKB-K-005
■ CKB-K-006
■ CKB-K-007



Bottom Perforated
Altan Delikli Konteyner

Code	Dimension	Weight
CKB-10-01	580x280x100mm	1900gr.
CKB-13-01	580x280x135mm	2420gr.
CKB-15-01	580x280x150mm	2500gr.
CKB-20-01	580x280x200mm	2760gr.
CKB-26-01	580x280x260mm	3100gr.



Bottom Non Perforated
Altan Deliksiz Konteyner

Code	Dimension	Weight
CKB-10-00	580x280x100mm	1800gr.
CKB-13-00	580x280x135mm	2100gr.
CKB-15-00	580x280x150mm	2300gr.
CKB-20-00	580x280x200mm	2660gr.
CKB-26-00	580x280x260mm	3000gr.

Edition Plus Series Sterilization Container Systems



Barrier Valve Filter System



1/2 Half Size - Küçük Boy

Barrier Lid System / Bariyer Kapaklı Sistem



285x280mm
930gr.

- CKK-BK-001
- CKK-BK-002
- CKK-BK-003
- CKK-BK-004
- CKK-BK-005
- CKK-BK-006
- CKK-BK-007



Bottom Perforated Altan Delikli Konteyner

Code	Dimension	Weight
CKK-B-10-01	285x280x100mm	2060gr.
CKK-B-13-01	285x280x135mm	2110gr.
CKK-B-15-01	285x280x150mm	2195gr.
CKK-B-20-01	285x280x200mm	2385gr.
CKK-B-26-01	285x280x260mm	2470gr.



Bottom Non Perforated Altan Deliksiz Konteyner

Code	Dimension	Weight
CKK-10-00	285x280x100mm	1360gr.
CKK-13-00	285x280x135mm	1410gr.
CKK-15-00	285x280x150mm	1490gr.
CKK-20-00	285x280x200mm	1645gr.
CKK-26-00	285x280x260mm	1800gr.

Bottom Non Perforated

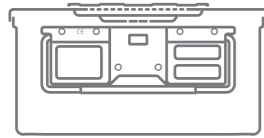

285x280x100mm 2870gr.	285x280x135mm 2940gr.	285x280x150mm 3020gr.	285x280x200mm 3175gr.	285x280x260mm 3300gr.
CKK-B-10-001	CKK-B-13-001	CKK-B-15-001	CKK-B-20-001	CKK-B-26-001
CKK-B-10-002	CKK-B-13-002	CKK-B-15-002	CKK-B-20-002	CKK-B-26-002
CKK-B-10-003	CKK-B-13-003	CKK-B-15-003	CKK-B-20-003	CKK-B-26-003
CKK-B-10-004	CKK-B-13-004	CKK-B-15-004	CKK-B-20-004	CKK-B-26-004
CKK-B-10-005	CKK-B-13-005	CKK-B-15-005	CKK-B-20-005	CKK-B-26-005
CKK-B-10-006	CKK-B-13-006	CKK-B-15-006	CKK-B-20-006	CKK-B-26-006
CKK-B-10-007	CKK-B-13-007	CKK-B-15-007	CKK-B-20-007	CKK-B-26-007

Bottom Perforated



285x280x100mm 2990gr.	285x280x135mm 3040gr.	285x280x150mm 3125gr.	285x280x200mm 3315gr.	285x280x260mm 3400gr.
CKK-B-10-011	CKK-B-13-011	CKK-B-15-011	CKK-B-20-011	CKK-B-26-011
CKK-B-10-012	CKK-B-13-012	CKK-B-15-012	CKK-B-20-012	CKK-B-26-012
CKK-B-10-013	CKK-B-13-013	CKK-B-15-013	CKK-B-20-013	CKK-B-26-013
CKK-B-10-014	CKK-B-13-014	CKK-B-15-014	CKK-B-20-014	CKK-B-26-014
CKK-B-10-015	CKK-B-13-015	CKK-B-15-015	CKK-B-20-015	CKK-B-26-015
CKK-B-10-016	CKK-B-13-016	CKK-B-15-016	CKK-B-20-016	CKK-B-26-016
CKK-B-10-017	CKK-B-13-017	CKK-B-15-017	CKK-B-20-017	CKK-B-26-017

Edition Plus Series Sterilization Container Systems



Barrier Valve Filter System



3/4 Middle Size - Orta Boy

Barrier Lid System / Bariyer Kapaklı Sistem



465x280mm
1180gr.

- CKO-BK-001
- CKO-BK-002
- CKO-BK-003
- CKO-BK-004
- CKO-BK-005
- CKO-BK-006
- CKO-BK-007



Bottom Perforated Altan Delikli Konteyner

Code	Dimension	Weight
CKO-B-10-01	465x280x100mm	2320gr.
CKO-B-13-01	465x280x135mm	2470gr.
CKO-B-15-01	465x280x150mm	2670gr.
CKO-B-20-01	465x280x200mm	2840gr.



Bottom Non Perforated Altan Deliksiz Konteyner

Code	Dimension	Weight
CKO-10-00	465x280x100mm	1550gr.
CKO-13-00	465x280x135mm	1700gr.
CKO-15-00	465x280x150mm	1800gr.
CKO-20-00	465x280x200mm	1950gr.

Bottom Non Perforated

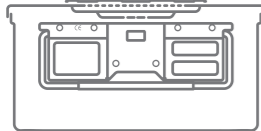

285x280x100mm 2870gr.	465x280x135mm 3500gr.	465x280x150mm 3580gr.	465x280x200mm 3720gr.
■ CKO-B-10-001	■ CKO-B-13-001	■ CKO-B-15-001	■ CKO-B-20-001
■ CKO-B-10-002	■ CKO-B-13-002	■ CKO-B-15-002	■ CKO-B-20-002
■ CKO-B-10-003	■ CKO-B-13-003	■ CKO-B-15-003	■ CKO-B-20-003
■ CKO-B-10-004	■ CKO-B-13-004	■ CKO-B-15-004	■ CKO-B-20-004
■ CKO-B-10-005	■ CKO-B-13-005	■ CKO-B-15-005	■ CKO-B-20-005
■ CKO-B-10-006	■ CKO-B-13-006	■ CKO-B-15-006	■ CKO-B-20-006
■ CKO-B-10-007	■ CKO-B-13-007	■ CKO-B-15-007	■ CKO-B-20-007

Bottom Perforated

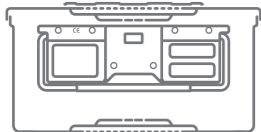

465x280x100mm 3500gr.	465x280x135mm 3650gr.	465x280x150mm 3850gr.	465x280x200mm 4020gr.
■ CKO-B-10-011	■ CKO-B-13-011	■ CKO-B-15-011	■ CKO-B-20-011
■ CKO-B-10-012	■ CKO-B-13-012	■ CKO-B-15-012	■ CKO-B-20-012
■ CKO-B-10-013	■ CKO-B-13-013	■ CKO-B-15-013	■ CKO-B-20-013
■ CKO-B-10-014	■ CKO-B-13-014	■ CKO-B-15-014	■ CKO-B-20-014
■ CKO-B-10-015	■ CKO-B-13-015	■ CKO-B-15-015	■ CKO-B-20-015
■ CKO-B-10-016	■ CKO-B-13-016	■ CKO-B-15-016	■ CKO-B-20-016
■ CKO-B-10-017	■ CKO-B-13-017	■ CKO-B-15-017	■ CKO-B-20-017

Edition Plus Series Sterilization Container Systems



Barrier Valve Filter System



1/1 Full Size - Büyük Boy

Barrier Lid System / Bariyer Kapaklı Sistem



580x280mm
1780gr.

- CKB-BK-001
- CKB-BK-002
- CKB-BK-003
- CKB-BK-004
- CKB-BK-005
- CKB-BK-006
- CKB-BK-007



Bottom Perforated Altan Delikli Konteyner

Code	Dimension	Weight
CKB-B-10-01	580x280x100mm	3070gr.
CKB-B-13-01	580x280x135mm	3540gr.
CKB-B-15-01	580x280x150mm	3620gr.
CKB-B-20-01	580x280x200mm	3880gr.
CKB-B-26-01	580x280x260mm	4290gr.



Bottom Non Perforated Altan Deliksiz Konteyner

Code	Dimension	Weight
CKB-10-00	580x280x100mm	1800gr.
CKB-13-00	580x280x135mm	2100gr.
CKB-15-00	580x280x150mm	2300gr.
CKB-20-00	580x280x200mm	2660gr.
CKB-26-00	580x280x260mm	3000gr.

Bottom Non Perforated

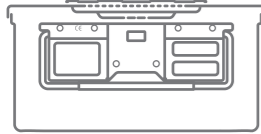

580x280x100mm 4700gr.	580x280x135mm 5000gr.	580x280x150mm 5200gr.	580x280x200mm 5560gr.	580x280x260mm 5900gr.
■ CKB-B-10-001	■ CKB-B-13-001	■ CKB-B-15-001	■ CKB-B-20-001	■ CKB-B-26-001
■ CKB-B-10-002	■ CKB-B-13-002	■ CKB-B-15-002	■ CKB-B-20-002	■ CKB-B-26-002
■ CKB-B-10-003	■ CKB-B-13-003	■ CKB-B-15-003	■ CKB-B-20-003	■ CKB-B-26-003
■ CKB-B-10-004	■ CKB-B-13-004	■ CKB-B-15-004	■ CKB-B-20-004	■ CKB-B-26-004
■ CKB-B-10-005	■ CKB-B-13-005	■ CKB-B-15-005	■ CKB-B-20-005	■ CKB-B-26-005
■ CKB-B-10-006	■ CKB-B-13-006	■ CKB-B-15-006	■ CKB-B-20-006	■ CKB-B-26-006
■ CKB-B-10-007	■ CKB-B-13-007	■ CKB-B-15-007	■ CKB-B-20-007	■ CKB-B-26-007

Bottom Perforated



580x280x100mm 4850gr.	580x280x135mm 5320gr.	580x280x150mm 5400gr.	580x280x200mm 5660gr.	580x280x260mm 6070gr.
■ CKB-B-10-011	■ CKB-B-13-011	■ CKB-B-15-011	■ CKB-B-20-011	■ CKB-B-26-011
■ CKB-B-10-012	■ CKB-B-13-012	■ CKB-B-15-012	■ CKB-B-20-012	■ CKB-B-26-012
■ CKB-B-10-013	■ CKB-B-13-013	■ CKB-B-15-013	■ CKB-B-20-013	■ CKB-B-26-013
■ CKB-B-10-014	■ CKB-B-13-014	■ CKB-B-15-014	■ CKB-B-20-014	■ CKB-B-26-014
■ CKB-B-10-015	■ CKB-B-13-015	■ CKB-B-15-015	■ CKB-B-20-015	■ CKB-B-26-015
■ CKB-B-10-016	■ CKB-B-13-016	■ CKB-B-15-016	■ CKB-B-20-016	■ CKB-B-26-016
■ CKB-B-10-017	■ CKB-B-13-017	■ CKB-B-15-017	■ CKB-B-20-017	■ CKB-B-26-017

Edition Plus Series Sterilization Container Systems



Safe Guardian System



1/2 Half Size - Küçük Boy



Filter Holder Lid / Filtre Tutuculu Kapak

285x280mm 1340gr.	
■	CKK-K-111
■	CKK-K-112
■	CKK-K-113
■	CKK-K-114
■	CKK-K-115
■	CKK-K-116
■	CKK-K-117

Bottom Non Perforated

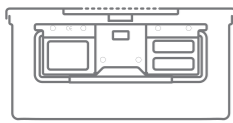

285x280x100mm 3119gr.	285x280x135mm 3240gr.	285x280x150mm 3320gr.	285x280x200mm 34750gr.	285x280x260mm 3600gr.
■ CKK-10-101	■ CKK-13-101	■ CKK-15-101	■ CKK-20-101	■ CKK-26-101
■ CKK-10-102	■ CKK-13-102	■ CKK-15-102	■ CKK-20-102	■ CKK-26-102
■ CKK-10-103	■ CKK-13-103	■ CKK-15-103	■ CKK-20-103	■ CKK-26-103
■ CKK-10-104	■ CKK-13-104	■ CKK-15-104	■ CKK-20-104	■ CKK-26-104
■ CKK-10-105	■ CKK-13-105	■ CKK-15-105	■ CKK-20-105	■ CKK-26-105
■ CKK-10-106	■ CKK-13-106	■ CKK-15-106	■ CKK-20-106	■ CKK-26-106
■ CKK-10-107	■ CKK-13-107	■ CKK-15-107	■ CKK-20-107	■ CKK-26-107

Bottom Perforated

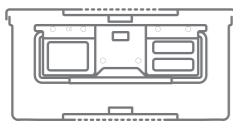

285x280x100mm 3290gr.	285x280x135mm 3340gr.	285x280x150mm 3425gr.	285x280x200mm 3615gr.	285x280x260mm 3700gr.
■ CKK-10-111	■ CKK-13-111	■ CKK-15-111	■ CKK-20-111	■ CKK-26-111
■ CKK-10-112	■ CKK-13-112	■ CKK-15-112	■ CKK-20-112	■ CKK-26-112
■ CKK-10-113	■ CKK-13-113	■ CKK-15-113	■ CKK-20-113	■ CKK-26-113
■ CKK-10-114	■ CKK-13-114	■ CKK-15-114	■ CKK-20-114	■ CKK-26-114
■ CKK-10-115	■ CKK-13-115	■ CKK-15-115	■ CKK-20-115	■ CKK-26-115
■ CKK-10-116	■ CKK-13-116	■ CKK-15-116	■ CKK-20-116	■ CKK-26-116
■ CKK-10-117	■ CKK-13-117	■ CKK-15-117	■ CKK-20-117	■ CKK-26-117



Bottom Perforated
Altan Delikli Konteyner

Code	Dimension	Weight
CKK-10-01	285x280x100mm	1460gr.
CKK-13-01	285x280x135mm	1510gr.
CKK-15-01	285x280x150mm	1595gr.
CKK-20-01	285x280x200mm	1785gr.
CKK-26-01	285x280x260mm	1920gr.



Bottom Non Perforated
Altan Deliksiz Konteyner

Code	Dimension	Weight
CKK-10-00	285x280x100mm	1360gr.
CKK-13-00	285x280x135mm	1410gr.
CKK-15-00	285x280x150mm	1490gr.
CKK-20-00	285x280x200mm	1645gr.
CKK-26-00	285x280x260mm	1800gr.

Edition Plus Series Sterilization Container Systems



Safe Guardian System



3/4 Middle Size - Orta Boy

Filter Holder Lid / Filtre Tutuculu Kapak



465x280mm
1100gr.

- CKO - K-111
- CKO - K-112
- CKO - K-113
- CKO - K-114
- CKO - K-115
- CKO - K-116
- CKO - K-117

Bottom Non Perforated

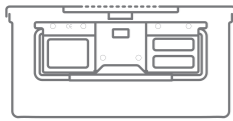

465x280x100mm 3650gr.	465x280x135mm 3800gr.	465x280x150mm 3890gr	465x280x200mm 4200gr.
■ CKO-10-101	■ CKO-13-101	■ CKO-15-101	■ CKO-20-101
■ CKO-10-102	■ CKO-13-102	■ CKO-15-102	■ CKO-20-102
■ CKO-10-103	■ CKO-13-103	■ CKO-15-103	■ CKO-20-103
■ CKO-10-104	■ CKO-13-104	■ CKO-15-104	■ CKO-20-104
■ CKO-10-105	■ CKO-13-105	■ CKO-15-105	■ CKO-20-105
■ CKO-10-106	■ CKO-13-106	■ CKO-15-106	■ CKO-20-106
■ CKO-10-107	■ CKO-13-107	■ CKO-15-107	■ CKO-20-107

Bottom Perforated

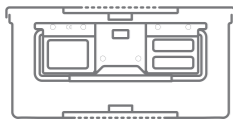

465x280x100mm 3800gr.	465x280x135mm 3950gr	465x280x150mm 4150gr.	465x280x200mm 4300gr.
■ CKO-10-111	■ CKO-13-111	■ CKO-15-111	■ CKO-20-111
■ CKO-10-112	■ CKO-13-112	■ CKO-15-112	■ CKO-20-112
■ CKO-10-113	■ CKO-13-113	■ CKO-15-113	■ CKO-20-113
■ CKO-10-114	■ CKO-13-114	■ CKO-15-114	■ CKO-20-114
■ CKO-10-115	■ CKO-13-115	■ CKO-15-115	■ CKO-20-115
■ CKO-10-116	■ CKO-13-116	■ CKO-15-116	■ CKO-20-116
■ CKO-10-117	■ CKO-13-117	■ CKO-15-117	■ CKO-20-117



Bottom Perforated
Altan Delikli Konteyner

Code	Dimension	Weight
CKO-10-01	465x280x100mm	1700gr.
CKO-13-01	465x280x135mm	1850gr.
CKO-15-01	465x280x150mm	1950gr.
CKO-20-01	465x280x200mm	2100gr.



Bottom Non Perforated
Altan Deliksiz Konteyner

Code	Dimension	Weight
CKO-10-00	465x280x100mm	1550gr.
CKO-13-00	465x280x135mm	1700gr.
CKO-15-00	465x280x150mm	1800gr.
CKO-20-00	465x280x200mm	1950gr.

Edition Plus Series Sterilization Container Systems

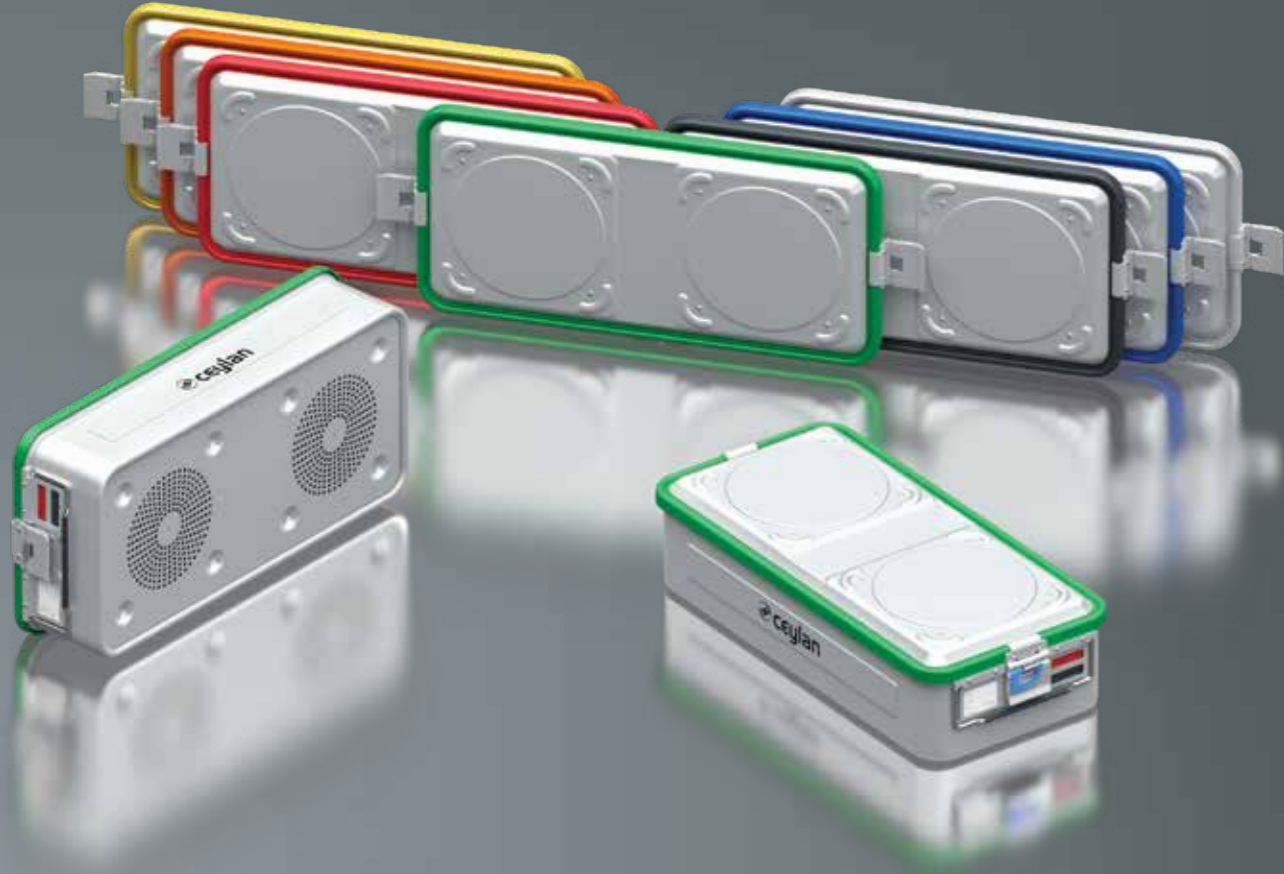

Safe Guardian System



1/1 Full Size - Büyük Boy

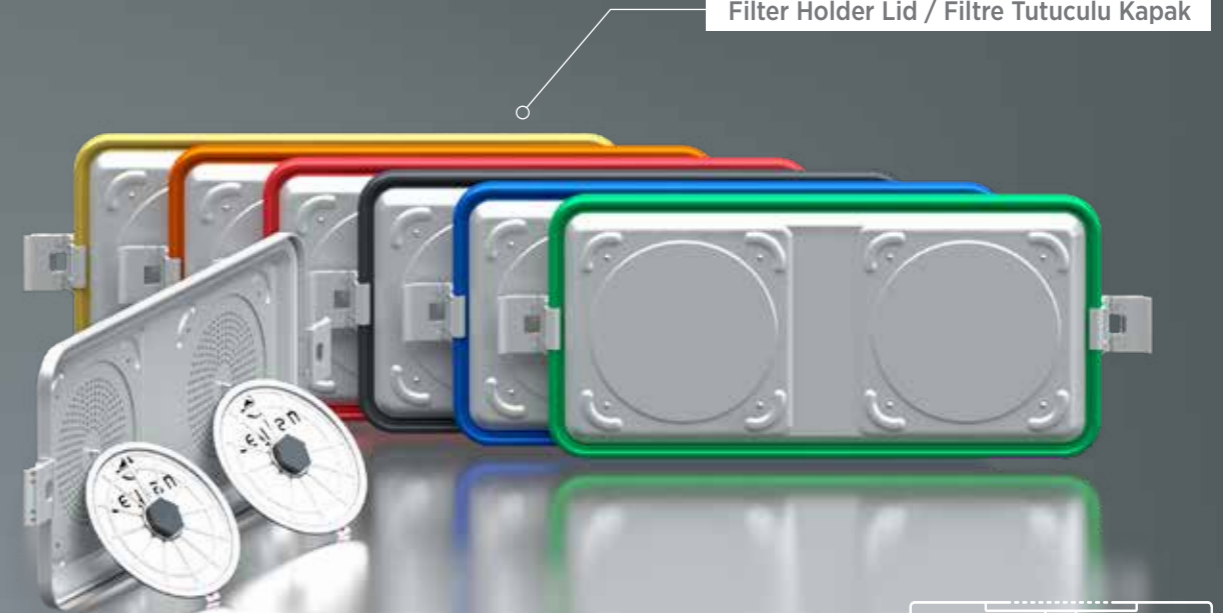

580x280mm 1500gr.	
■	CKB-K-111
■	CKB-K-112
■	CKB-K-113
■	CKB-K-114
■	CKB-K-115
■	CKB-K-116
■	CKB-K-117

Bottom Non Perforated

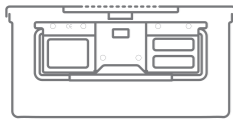

580x280x100mm 5300gr.	580x280x135mm 5600gr.	580x280x150mm 5800gr.	580x280x200mm 6160gr.	580x280x260mm 6450gr.
■ CKB-10-101	■ CKB-13-101	■ CKB-15-101	■ CKB-20-101	■ CKB-26-101
■ CKB-10-102	■ CKB-13-102	■ CKB-15-102	■ CKB-20-102	■ CKB-26-102
■ CKB-10-103	■ CKB-13-103	■ CKB-15-103	■ CKB-20-103	■ CKB-26-103
■ CKB-10-104	■ CKB-13-104	■ CKB-15-104	■ CKB-20-104	■ CKB-26-104
■ CKB-10-105	■ CKB-13-105	■ CKB-15-105	■ CKB-20-105	■ CKB-26-105
■ CKB-10-106	■ CKB-13-106	■ CKB-15-106	■ CKB-20-106	■ CKB-26-106
■ CKB-10-107	■ CKB-13-107	■ CKB-15-107	■ CKB-20-107	■ CKB-26-107

Bottom Perforated

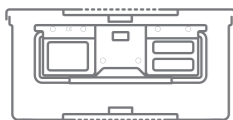

580x280x100mm 5400gr.	580x280x135mm 5920gr.	580x280x150mm 6000gr.	580x280x200mm 6260gr.	580x280x260mm 6630gr.
■ CKB-10-111	■ CKB-13-111	■ CKB-15-111	■ CKB-20-111	■ CKB-26-111
■ CKB-10-112	■ CKB-13-112	■ CKB-15-112	■ CKB-20-112	■ CKB-26-112
■ CKB-10-113	■ CKB-13-113	■ CKB-15-113	■ CKB-20-113	■ CKB-26-113
■ CKB-10-114	■ CKB-13-114	■ CKB-15-114	■ CKB-20-114	■ CKB-26-114
■ CKB-10-115	■ CKB-13-115	■ CKB-15-115	■ CKB-20-115	■ CKB-26-115
■ CKB-10-116	■ CKB-13-116	■ CKB-15-116	■ CKB-20-116	■ CKB-26-116
■ CKB-10-117	■ CKB-13-117	■ CKB-15-117	■ CKB-20-117	■ CKB-26-117



Bottom Perforated
Altan Delikli Konteyner

Code	Dimension	Weight
CKB-10-01	580x280x100mm	1900gr.
CKB-13-01	580x280x135mm	2420gr.
CKB-15-01	580x280x150mm	2500gr.
CKB-20-01	580x280x200mm	2760gr.
CKB-26-01	580x280x260mm	3100gr.



Bottom Non Perforated
Altan Deliksiz Konteyner

Code	Dimension	Weight
CKB-10-00	580x280x100mm	1800gr.
CKB-13-00	580x280x135mm	2100gr.
CKB-15-00	580x280x150mm	2300gr.
CKB-20-00	580x280x200mm	2660gr.
CKB-26-00	580x280x260mm	3000gr.

Edition Plus Series Sterilization Container Systems



Dismountable Barrier Filter System



1/2 Half Size - Küçük Boy



285x280mm
930gr.

- CKK-BK1-001
- CKK-BK1-002
- CKK-BK1-003
- CKK-BK1-004
- CKK-BK1-005
- CKK-BK1-006
- CKK-BK1-007

Bottom Non Perforated

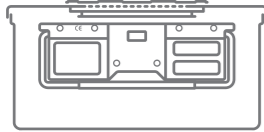

285x280x100mm 2870gr.	285x280x135mm 2940gr.	285x280x150mm 3020gr.	285x280x200mm 3175gr	285x280x260mm 3300gr.
■ CKK-B1-10-001	■ CKK-B1-13-001	■ CKK-B1-15-001	■ CKK-B1-20-001	■ CKK-B1-26-001
■ CKK-B1-10-002	■ CKK-B1-13-002	■ CKK-B1-15-002	■ CKK-B1-20-002	■ CKK-B1-26-002
■ CKK-B1-10-003	■ CKK-B1-13-003	■ CKK-B1-15-003	■ CKK-B1-20-003	■ CKK-B1-26-003
■ CKK-B1-10-004	■ CKK-B1-13-004	■ CKK-B1-15-004	■ CKK-B1-20-004	■ CKK-B1-26-004
■ CKK-B1-10-005	■ CKK-B1-13-005	■ CKK-B1-15-005	■ CKK-B1-20-005	■ CKK-B1-26-005
■ CKK-B1-10-006	■ CKK-B1-13-006	■ CKK-B1-15-006	■ CKK-B1-20-006	■ CKK-B1-26-006
■ CKK-B1-10-007	■ CKK-B1-13-007	■ CKK-B1-15-007	■ CKK-B1-20-007	■ CKK-B1-26-007

Bottom Perforated

285x280x100mm 2990gr.	285x280x135mm 3040gr.	285x280x150mm 3125gr.	285x280x200mm 3315gr	285x280x260mm 3400gr
■ CKK-B1-10-011	■ CKK-B1-13-011	■ CKK-B1-15-011	■ CKK-B1-20-011	■ CKK-B1-26-011
■ CKK-B1-10-012	■ CKK-B1-13-012	■ CKK-B1-15-012	■ CKK-B1-20-012	■ CKK-B1-26-012
■ CKK-B1-10-013	■ CKK-B1-13-013	■ CKK-B1-15-013	■ CKK-B1-20-013	■ CKK-B1-26-013
■ CKK-B1-10-014	■ CKK-B1-13-014	■ CKK-B1-15-014	■ CKK-B1-20-014	■ CKK-B1-26-014
■ CKK-B1-10-015	■ CKK-B1-13-015	■ CKK-B1-15-015	■ CKK-B1-20-015	■ CKK-B1-26-015
■ CKK-B1-10-016	■ CKK-B1-13-016	■ CKK-B1-15-016	■ CKK-B1-20-016	■ CKK-B1-26-016
■ CKK-B1-10-017	■ CKK-B1-13-017	■ CKK-B1-15-017	■ CKK-B1-20-017	■ CKK-B1-26-017



Bottom Perforated
Altan Delikli Konteyner

Code	Dimension	Weight
CKK-B1-10-01	285x280x100mm	2060gr.
CKK-B1-13-01	285x280x135mm	2110gr.
CKK-B1-15-01	285x280x150mm	2195gr.
CKK-B1-20-01	285x280x200mm	2385gr.
CKK-B1-26-01	285x280x260mm	2470gr



Bottom Non Perforated
Altan Deliksiz Konteyner

Code	Dimension	Weight
CKK-10-00	285x280x100mm	1360gr.
CKK-13-00	285x280x135mm	1410gr.
CKK-15-00	285x280x150mm	1490gr.
CKK-20-00	285x280x200mm	1645gr.
CKK-26-00	285x280x260mm	1800gr.

Edition Plus Series Sterilization Container Systems



Dismountable Barrier Filter System



3/4 Middle Size - Orta Boy



465x280mm
1180gr.

█	CKO-BK1-001
█	CKO-BK1-002
█	CKO-BK1-003
█	CKO-BK1-004
█	CKO-BK1-005
█	CKO-BK1-006
█	CKO-BK1-007

Bottom Non Perforated

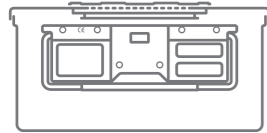

465x280x100mm 3350gr.	465x280x135mm 3350gr.	465x280x150mm 3580gr.	465x280x200mm 3720gr.
█	█	█	█
█	█	█	█
█	█	█	█
█	█	█	█
█	█	█	█
█	█	█	█
█	█	█	█
█	█	█	█

Bottom Perforated

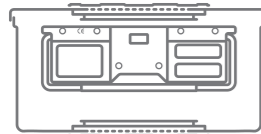

465x280x100mm 3500gr.	465x280x135mm 3650gr.	465x280x150mm 3850gr.	465x280x200mm 4020gr.
█	█	█	█
█	█	█	█
█	█	█	█
█	█	█	█
█	█	█	█
█	█	█	█
█	█	█	█
█	█	█	█



Bottom Perforated
Altan Delikli Konteyner

Code	Dimension	Weight
CKO-BI-10-01	465x280x100mm	2320gr.
CKO-BI-13-01	465x280x135mm	2470gr.
CKO-BI-15-01	465x280x150mm	2670gr.
CKO-BI-20-01	465x280x200mm	2840gr.



Bottom Non Perforated
Altan Deliksiz Konteyner

Code	Dimension	Weight
CKO-10-00	465x280x100mm	1550gr.
CKO-13-00	465x280x135mm	1700gr.
CKO-15-00	465x280x150mm	1800gr.
CKO-20-00	465x280x200mm	1950gr.

Edition Plus Series Sterilization Container Systems



Dismountable Barrier Filter System



1/1 Full Size - Büyük Boy

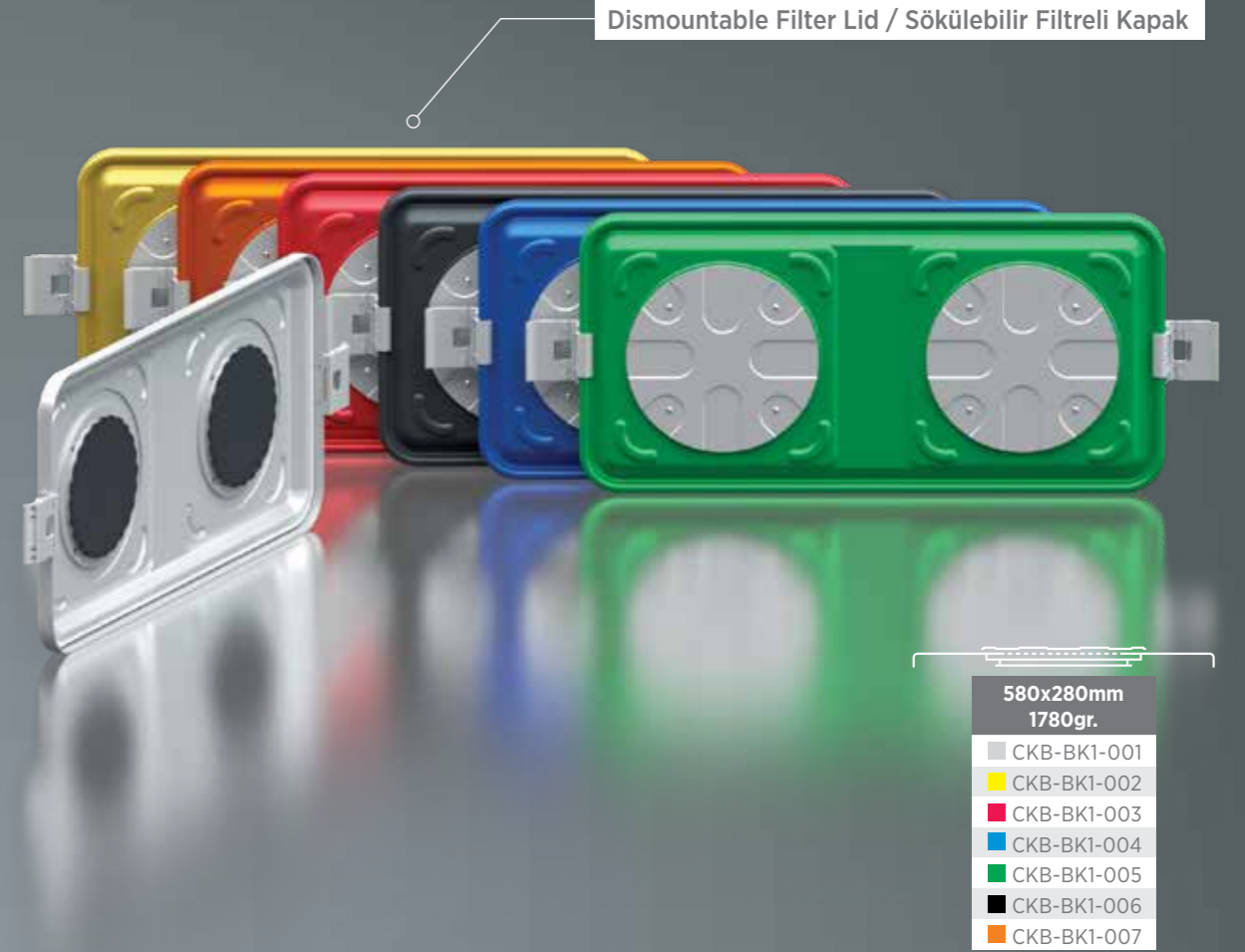

580x280mm
1780gr.

- CKB-BK1-001
- CKB-BK1-002
- CKB-BK1-003
- CKB-BK1-004
- CKB-BK1-005
- CKB-BK1-006
- CKB-BK1-007

Bottom Non Perforated

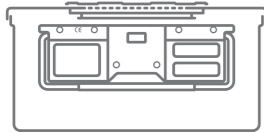

580x280x100mm 4700gr.	580x280x135mm 5000gr	580x280x150mm 5200gr	580x280x200mm 5560gr.	580x280x260mm 5900gr.
■ CKB-BI-10-001	■ CKB-BI-13-001	■ CKB-BI-15-001	■ CKB-BI-20-001	■ CKB-BI-26-001
■ CKB-BI-10-002	■ CKB-BI-13-002	■ CKB-BI-15-002	■ CKB-BI-20-002	■ CKB-BI-26-002
■ CKB-BI-10-003	■ CKB-BI-13-003	■ CKB-BI-15-003	■ CKB-BI-20-003	■ CKB-BI-26-003
■ CKB-BI-10-004	■ CKB-BI-13-004	■ CKB-BI-15-004	■ CKB-BI-20-004	■ CKB-BI-26-004
■ CKB-BI-10-005	■ CKB-BI-13-005	■ CKB-BI-15-005	■ CKB-BI-20-005	■ CKB-BI-26-005
■ CKB-BI-10-006	■ CKB-BI-13-006	■ CKB-BI-15-006	■ CKB-BI-20-006	■ CKB-BI-26-006
■ CKB-BI-10-007	■ CKB-BI-13-007	■ CKB-BI-15-007	■ CKB-BI-20-007	■ CKB-BI-26-007

Bottom Perforated

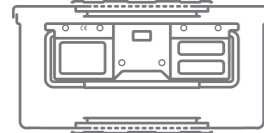

580x280x100mm 4850gr.	580x280x135mm 5320gr.	580x280x150mm 5400gr.	580x280x200mm 5660gr	580x280x260mm 6070gr.
■ CKB-BI-10-011	■ CKB-BI-13-011	■ CKB-BI-15-011	■ CKB-BI-20-011	■ CKB-BI-26-011
■ CKB-BI-10-012	■ CKB-BI-13-012	■ CKB-BI-15-012	■ CKB-BI-20-012	■ CKB-BI-26-012
■ CKB-BI-10-013	■ CKB-BI-13-013	■ CKB-BI-15-013	■ CKB-BI-20-013	■ CKB-BI-26-013
■ CKB-BI-10-014	■ CKB-BI-13-014	■ CKB-BI-15-014	■ CKB-BI-20-014	■ CKB-BI-26-014
■ CKB-BI-10-015	■ CKB-BI-13-015	■ CKB-BI-15-015	■ CKB-BI-20-015	■ CKB-BI-26-015
■ CKB-BI-10-016	■ CKB-BI-13-016	■ CKB-BI-15-016	■ CKB-BI-20-016	■ CKB-BI-26-016
■ CKB-BI-10-017	■ CKB-BI-13-017	■ CKB-BI-15-017	■ CKB-BI-20-017	■ CKB-BI-26-017



Bottom Perforated
Altan Delikli Konteyner

Code	Dimension	Weight
CKB-BI-10-01	580x280x100mm	3070gr.
CKB-BI-13-01	580x280x135mm	3540gr.
CKB-BI-15-01	580x280x150mm	3620gr.
CKB-BI-20-01	580x280x200mm	3880gr.
CKB-BI-26-01	580x280x260mm	4290gr.



Bottom Non Perforated
Altan Deliksiz Konteyner

Code	Dimension	Weight
CKB-10-00	580x280x100mm	1800gr.
CKB-13-00	580x280x135mm	2100gr.
CKB-15-00	580x280x150mm	2300gr.
CKB-20-00	580x280x200mm	2660gr.
CKB-26-00	580x280x260mm	3000gr.

Master Series Sterilization Container Systems



Standard Filter System



Bottom Non Perforated

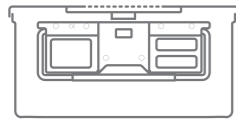

285x280x100mm 2190gr.	285x280x135mm 2240gr.	285x280x150mm 2320gr.	285x280x200mm 2475gr.	285x280x260mm 2630gr.
CAK-10-001	CAK-13-001	CAK-15-001	CAK-20-001	CAK-26-001
CAK-10-002	CAK-13-002	CAK-15-002	CAK-20-002	CAK-26-002
CAK-10-003	CAK-13-003	CAK-15-003	CAK-20-003	CAK-26-003
CAK-10-004	CAK-13-004	CAK-15-004	CAK-20-004	CAK-26-004
CAK-10-005	CAK-13-005	CAK-15-005	CAK-20-005	CAK-26-005
CAK-10-006	CAK-13-006	CAK-15-006	CAK-20-006	CAK-26-006
CAK-10-007	CAK-13-007	CAK-15-007	CAK-20-007	CAK-26-007

Bottom Perforated

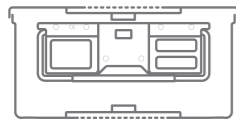

285x280x100mm 2290gr.	285x280x135mm 2340gr.	285x280x150mm 2425gr.	285x280x200mm 2615gr.	285x280x260mm 2730gr.
CAK-10-011	CAK-13-011	CAK-15-011	CAK-20-011	CAK-26-011
CAK-10-012	CAK-13-012	CAK-15-012	CAK-20-012	CAK-26-012
CAK-10-013	CAK-13-013	CAK-15-013	CAK-20-013	CAK-26-013
CAK-10-014	CAK-13-014	CAK-15-014	CAK-20-014	CAK-26-014
CAK-10-015	CAK-13-015	CAK-15-015	CAK-20-015	CAK-26-015
CAK-10-016	CAK-13-016	CAK-15-016	CAK-20-016	CAK-26-016
CAK-10-017	CAK-13-017	CAK-15-017	CAK-20-017	CAK-26-017

1/2 Half Size - Küçük Boy



Filter Holder Lid / Filtre Tutuculu Kapak

285x280mm
830gr.

CAK-K-011
CAK-K-012
CAK-K-013
CAK-K-014
CAK-K-015
CAK-K-016
CAK-K-017

285x280mm
670gr.

CAK-K-001
CAK-K-002
CAK-K-003
CAK-K-004
CAK-K-005
CAK-K-006
CAK-K-007

Non Filter Holder Lid / Filtre Tutucusuz Kapak



Bottom Perforated
Altan Delikli Konteyner

Code	Dimension	Weight
CAK-10-01	285x280x100mm	1460gr.
CAK-13-01	285x280x135mm	1510gr.
CAK-15-01	285x280x150mm	1595gr.
CAK-20-01	285x280x200mm	1785gr.
CAK-26-01	285x280x260mm	1920gr.



Bottom Non Perforated
Altan Deliksiz Konteyner

Code	Dimension	Weight
CAK-10-00	285x280x100mm	1360gr.
CAK-13-00	285x280x135mm	1410gr.
CAK-15-00	285x280x150mm	1490gr.
CAK-20-00	285x280x200mm	1645gr.
CAK-26-00	285x280x260mm	1800gr.

Master Series Sterilization Container Systems



Standard Filter System



3/4 Middle Size - Orta Boy

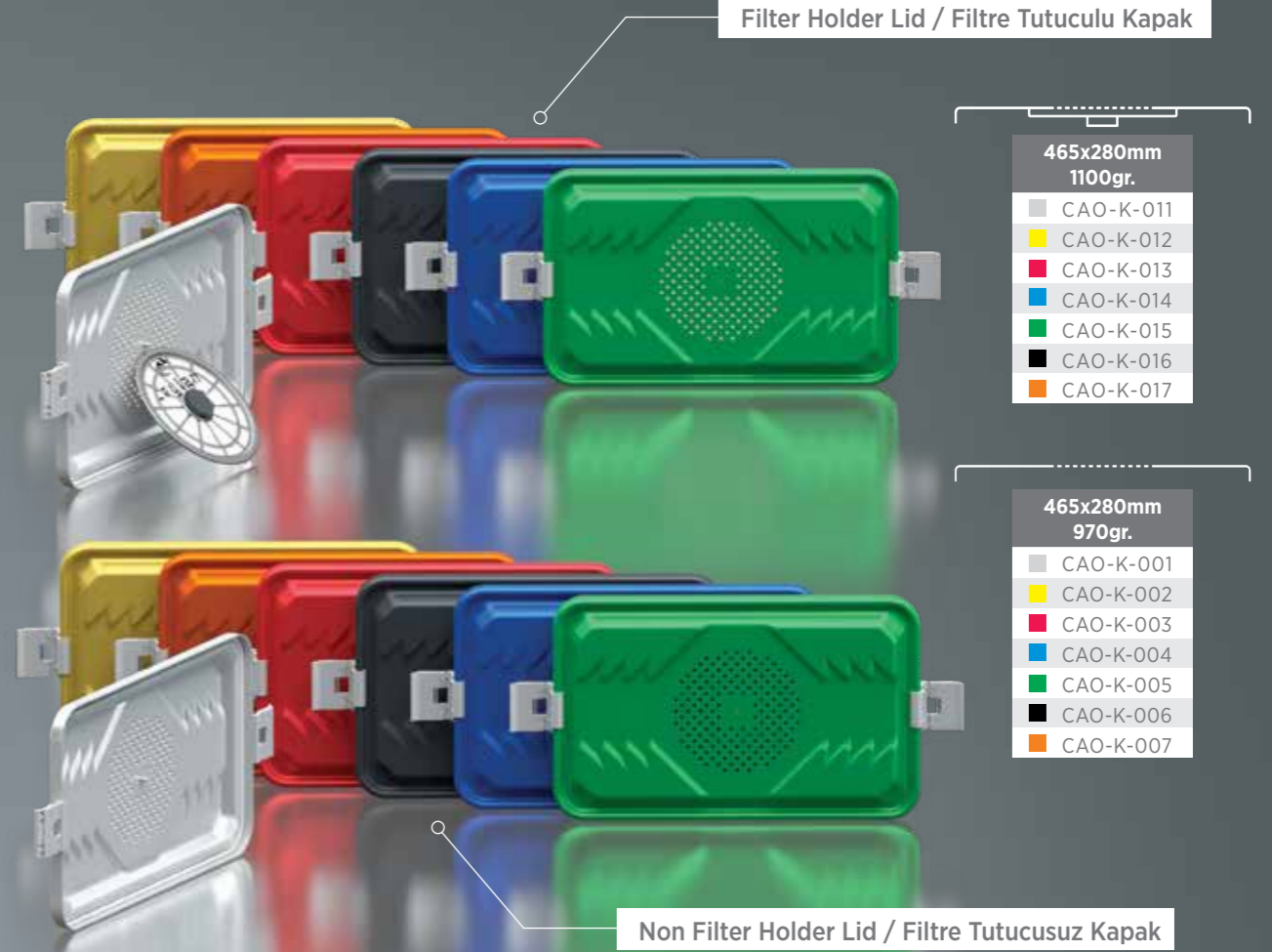

Filter Holder Lid / Filtre Tutuculu Kapak

465x280mm
1100gr.

- CAO-K-011
- CAO-K-012
- CAO-K-013
- CAO-K-014
- CAO-K-015
- CAO-K-016
- CAO-K-017

465x280mm
970gr.

- CAO-K-001
- CAO-K-002
- CAO-K-003
- CAO-K-004
- CAO-K-005
- CAO-K-006
- CAO-K-007

Non Filter Holder Lid / Filtre Tutucusuz Kapak



Bottom Perforated
Altan Delikli Konteyner

Code	Dimension	Weight
CAO-10-01	465x280x100mm	1700gr.
CAO-13-01	465x280x135mm	1850gr.
CAO-15-01	465x280x150mm	1950gr.
CAO-20-01	465x280x200mm	2100gr.



Bottom Non Perforated
Altan Deliksiz Konteyner

Code	Dimension	Weight
CAO-10-00	465x280x100mm	1550gr.
CAO-13-00	465x280x135mm	1700gr.
CAO-15-00	465x280x150mm	1800gr.
CAO-20-00	465x280x200mm	1950gr.

Bottom Non Perforated

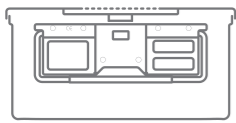

465x280x100mm 2650gr.	465x280x135mm 2800gr.	465x280x150mm 2900 gr.	465x280x200mm 3050gr.
CAO-10-001	CAO-13-001	CAO-15-001	CAO-20-001
CAO-10-002	CAO-13-002	CAO-15-002	CAO-20-002
CAO-10-003	CAK-13-003	CAO-15-003	CAO-20-003
CAO-10-004	CAO-13-004	CAO-15-004	CAO-20-004
CAO-10-005	CAO-13-005	CAO-15-005	CAO-20-005
CAO-10-006	CAK-13-006	CAK-15-006	CAO-20-006
CAO-10-007	CAO-13-007	CAO-15-007	CAO-20-007

Bottom Perforated

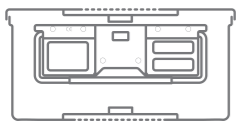

465x280x100mm 2800gr.	465x280x135mm 2950gr.	465x280x150mm 3050gr.	465x280x200mm 3200gr.
CAO-10-011	CAO-13-011	CAO-15-011	CAO-20-011
CAO-10-012	CAO-13-012	CAO-15-012	CAO-20-012
CAO-10-013	CAO-13-013	CAO-15-013	CAO-20-013
CAO-10-014	CAO-13-014	CAO-15-014	CAO-20-014
CAO-10-015	CAO-13-015	CAO-15-015	CAO-20-015
CAO-10-016	CAO-13-016	CAO-15-016	CAO-20-016
CAO-10-017	CAO-13-017	CAO-15-017	CAO-20-017

Master Series Sterilization Container Systems



Standard Filter System



Bottom Non Perforated

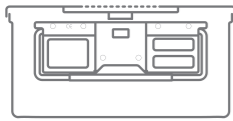

580x280x100mm 3300gr.	580x280x135mm 3600gr.	580x280x150mm 3800gr.	580x280x200mm 4160gr.	580x280x260mm 4500gr.
■ CAB-10-001	■ CAB-13-001	■ CAB-15-001	■ CAB-20-001	■ CAB-26-001
■ CAB-10-002	■ CAB-13-002	■ CAB-15-002	■ CAB-20-002	■ CAB-26-002
■ CAB-10-003	■ CAB-13-003	■ CAB-15-003	■ CAB-20-003	■ CAB-26-003
■ CAB-10-004	■ CAB-13-004	■ CAB-15-004	■ CAB-20-004	■ CAB-26-004
■ CAB-10-005	■ CAB-13-005	■ CAB-15-005	■ CAB-20-005	■ CAB-26-005
■ CAB-10-006	■ CAB-13-006	■ CAB-15-006	■ CAB-20-006	■ CAB-26-006
■ CAB-10-007	■ CAB-13-007	■ CAB-15-007	■ CAB-20-007	■ CAB-26-007

Bottom Perforated

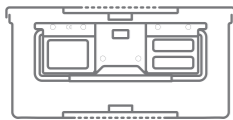

580x280x100mm 3400gr.	580x280x135mm 3920gr.	580x280x150mm 4000gr.	580x280x200mm 4260gr.	580x280x260mm 4600gr.
■ CAB-10-011	■ CAB-13-011	■ CAB-15-011	■ CAB-20-011	■ CAB-26-011
■ CAB-10-012	■ CAB-13-012	■ CAB-15-012	■ CAB-20-012	■ CAB-26-012
■ CAB-10-013	■ CAB-13-013	■ CAB-15-013	■ CAB-20-013	■ CAB-26-013
■ CAB-10-014	■ CAB-13-014	■ CAB-15-014	■ CAB-20-014	■ CAB-26-014
■ CAB-10-015	■ CAB-13-015	■ CAB-15-015	■ CAB-20-015	■ CAB-26-015
■ CAB-10-016	■ CAB-13-016	■ CAB-15-016	■ CAB-20-016	■ CAB-26-016
■ CAB-10-017	■ CAB-13-017	■ CAB-15-017	■ CAB-20-017	■ CAB-26-017

1/1 Full Size - Büyük Boy

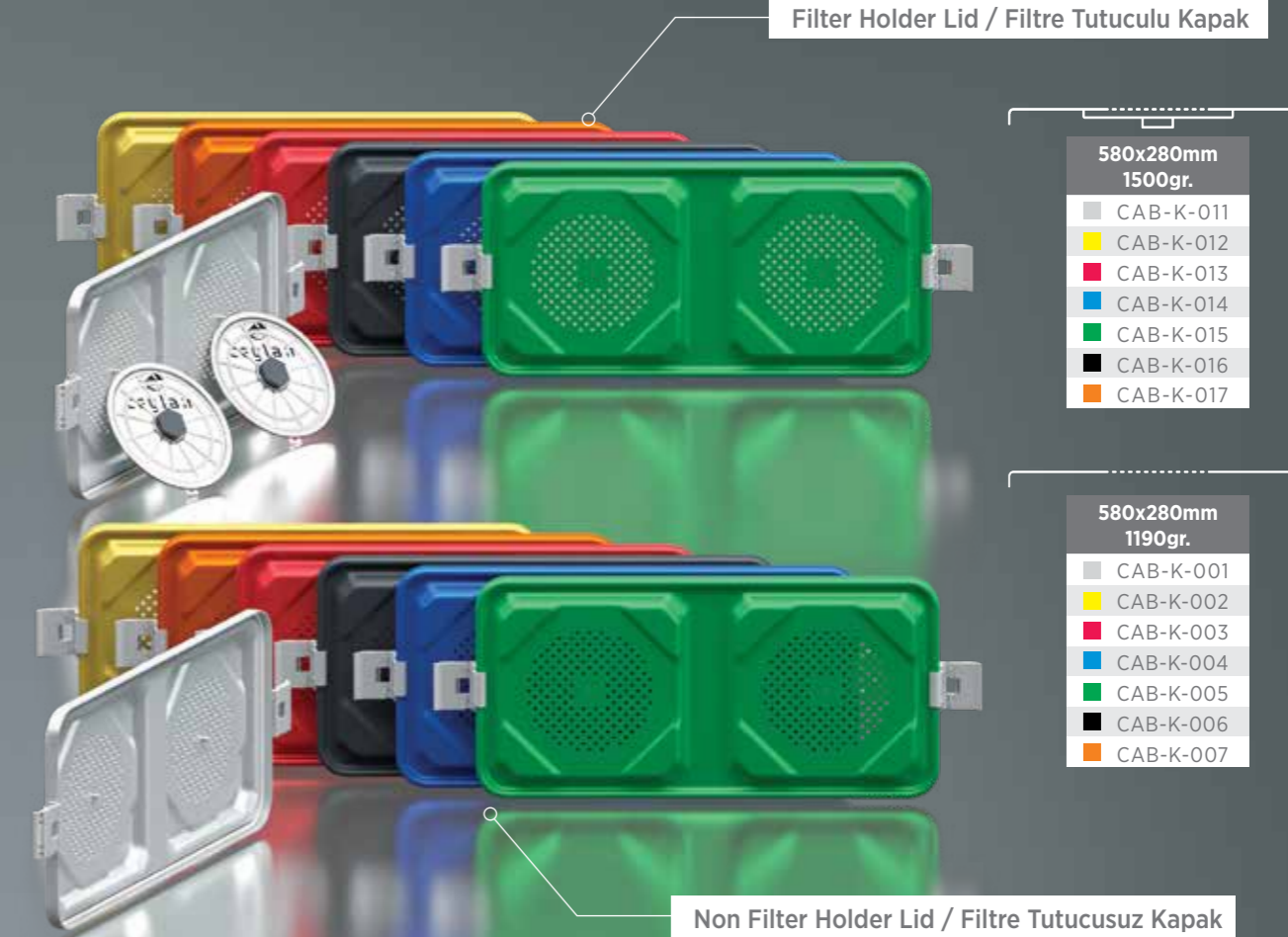

580x280mm
1500gr.

■ CAB-K-011
■ CAB-K-012
■ CAB-K-013
■ CAB-K-014
■ CAB-K-015
■ CAB-K-016
■ CAB-K-017

580x280mm
1190gr.

■ CAB-K-001
■ CAB-K-002
■ CAB-K-003
■ CAB-K-004
■ CAB-K-005
■ CAB-K-006
■ CAB-K-007

Non Filter Holder Lid / Filtre Tutucusuz Kapak



Bottom Perforated
Altın Delikli Konteyner

Code	Dimension	Weight
CAB-10-01	580x280x100mm	1900gr.
CAB-13-01	580x280x135mm	2420gr.
CAB-15-01	580x280x150mm	2500gr.
CAB-20-01	580x280x200mm	2760gr.
CAB-26-01	580x280x260mm	3100gr.



Bottom Non Perforated
Altın Deliksiz Konteyner

Code	Dimension	Weight
CAB-10-00	580x280x100mm	1800gr.
CAB-13-00	580x280x135mm	2100gr.
CAB-15-00	580x280x150mm	2300gr.
CAB-20-00	580x280x200mm	2660gr.
CAB-26-00	580x280x260mm	3000gr.

Master Series Sterilization Container Systems



Standard Filter System



1/2 Half Size - Küçük Boy



285x280mm
830gr.

- CYK-K-011
- CYK-K-012
- CYK-K-013
- CYK-K-014
- CYK-K-015
- CYK-K-016
- CYK-K-017

285x280mm
670gr.

- CYK-K-001
- CYK-K-002
- CYK-K-003
- CYK-K-004
- CYK-K-005
- CYK-K-006
- CYK-K-007

Non Filter Holder Lid / Filtre Tutucusuz Kapak

SUEDE CHANNEL FILTER SYSTEMS



Bottom Perforated
Altan Delikli Konteyner

Code	Dimension	Weight
CYK-10-01	285x280x100mm	1460gr.
CYK-13-01	285x280x135mm	1510gr.
CYK-15-01	285x280x150mm	1595gr.
CYK-20-01	285x280x200mm	1785gr.
CYK-26-01	285x280x260mm	1920gr.



Bottom Non Perforated
Altan Deliksiz Konteyner

Code	Dimension	Weight
CYK-10-00	285x280x100mm	1360gr.
CYK-13-00	285x280x135mm	1410gr.
CYK-15-00	285x280x150mm	1490gr.
CYK-20-00	285x280x200mm	1645gr.
CYK-26-00	285x280x260mm	1800gr.

Bottom Non Perforated

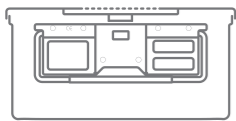

285x280x100mm 2190gr.	285x280x135mm 2240gr.	285x280x150mm 2320gr.	285x280x200mm 2475gr.	285x280x260mm 2630gr.
■ CYK-10-001	■ CYK-13-001	■ CYK-15-001	■ CYK-20-001	■ CYK-26-001
■ CYK-10-002	■ CYK-13-002	■ CYK-15-002	■ CYK-20-002	■ CYK-26-002
■ CYK-10-003	■ CYK-13-003	■ CYK-15-003	■ CYK-20-003	■ CYK-26-003
■ CYK-10-004	■ CYK-13-004	■ CYK-15-004	■ CYK-20-004	■ CYK-26-004
■ CYK-10-005	■ CYK-13-005	■ CYK-15-005	■ CYK-20-005	■ CYK-26-005
■ CYK-10-006	■ CYK-13-006	■ CYK-15-006	■ CYK-20-006	■ CYK-26-006
■ CYK-10-007	■ CYK-13-007	■ CYK-15-007	■ CYK-20-007	■ CYK-26-007

Bottom Perforated

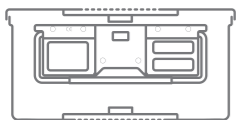

285x280x100mm 2290gr.	285x280x135mm 2340gr.	285x280x150mm 2425gr.	285x280x200mm 2615gr.	285x280x260mm 2730gr.
■ CYK-10-011	■ CYK-13-011	■ CYK-15-011	■ CYK-20-011	■ CYK-26-011
■ CYK-10-012	■ CYK-13-012	■ CYK-15-012	■ CYK-20-012	■ CYK-26-012
■ CYK-10-013	■ CYK-13-013	■ CYK-15-013	■ CYK-20-013	■ CYK-26-013
■ CYK-10-014	■ CYK-13-014	■ CYK-15-014	■ CYK-20-014	■ CYK-26-014
■ CYK-10-015	■ CYK-13-015	■ CYK-15-015	■ CYK-20-015	■ CYK-26-015
■ CYK-10-016	■ CYK-13-016	■ CYK-15-016	■ CYK-20-016	■ CYK-26-016
■ CYK-10-017	■ CYK-13-017	■ CYK-15-017	■ CYK-20-017	■ CYK-26-017

Master Series Sterilization Container Systems



Standard Filter System



3/4 Middle Size - Orta Boy

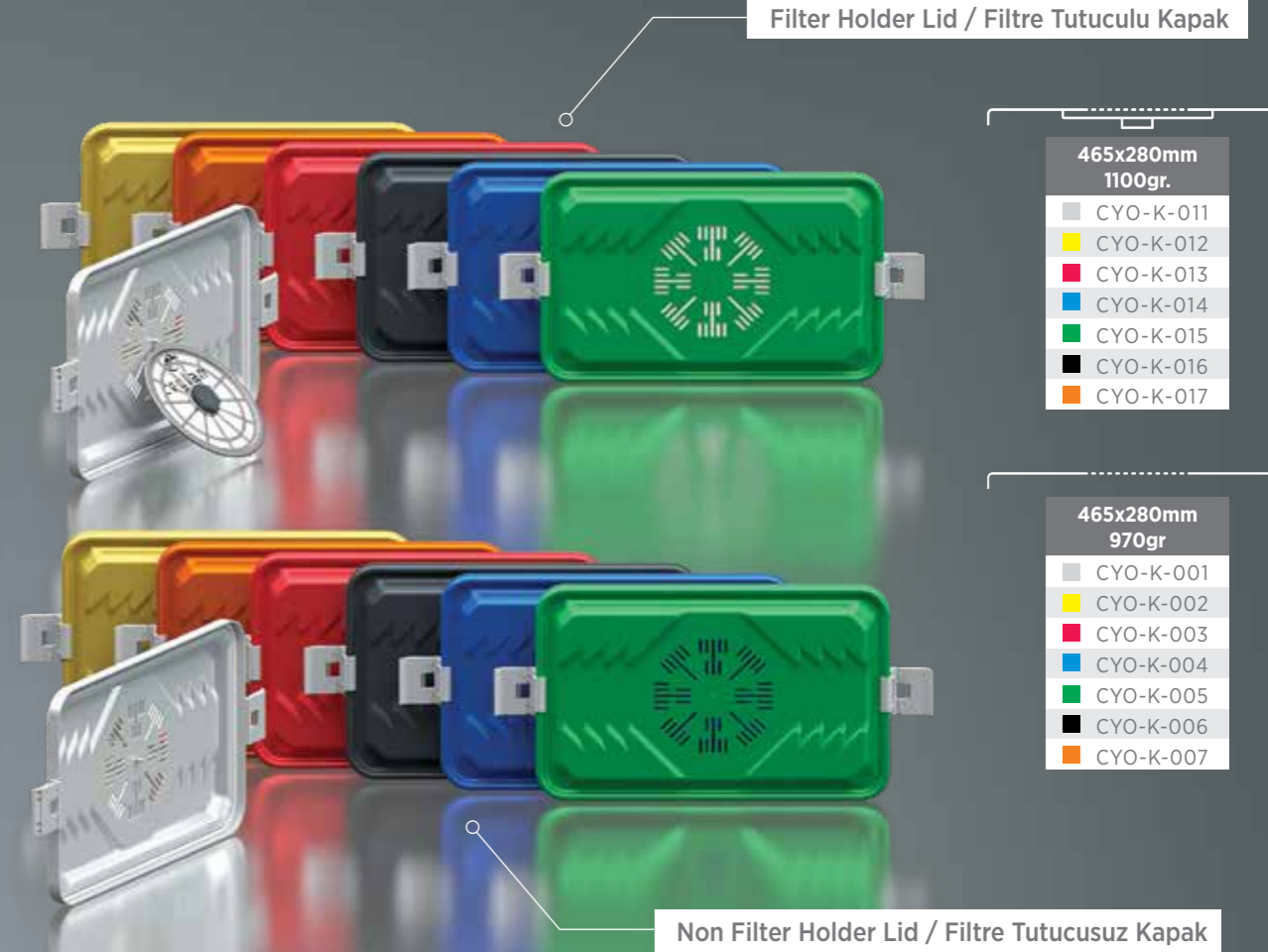

Filter Holder Lid / Filtre Tutuculu Kapak

465x280mm
1100gr.

- CYO-K-011
- CYO-K-012
- CYO-K-013
- CYO-K-014
- CYO-K-015
- CYO-K-016
- CYO-K-017

465x280mm
970gr

- CYO-K-001
- CYO-K-002
- CYO-K-003
- CYO-K-004
- CYO-K-005
- CYO-K-006
- CYO-K-007

Non Filter Holder Lid / Filtre Tutucusuz Kapak

SUEDE CHANNEL FILTER SYSTEMS



Bottom Perforated
Altan Delikli Konteyner

Code	Dimension	Weight
CYO-10-01	465x280x100mm	1700gr.
CYO-13-01	465x280x135mm	1850gr.
CYO-15-01	465x280x150mm	1950gr.
CYO-20-01	465x280x200mm	2100gr



Bottom Non Perforated
Altan Deliksiz Konteyner

Code	Dimension	Weight
CYO-10-00	465x280x100mm	1550gr.
CYO-13-00	465x280x135mm	1700gr.
CYO-15-00	465x280x150mm	1800gr.
CYO-20-00	465x280x200mm	1950gr

Bottom Non Perforated

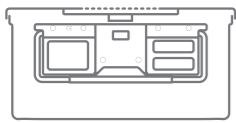

465x280x100mm
2650gr.

- CYO-10-001
- CYO-10-002
- CYO-10-003
- CYO-10-004
- CYO-10-005
- CYO-10-006
- CYO-10-007

465x280x135mm
2800gr.

- CYO-13-001
- CYO-13-002
- CYK-13-003
- CYO-13-004
- CYO-13-005
- CYK-13-006
- CYO-13-007

465x280x150mm
2900 gr.

- CYO-15-001
- CYO-15-002
- CYO-15-003
- CYO-15-004
- CYO-15-005
- CYO-15-006
- CYO-15-007

465x280x200mm
3050gr.

- CYO-20-001
- CYO-20-002
- CYO-20-003
- CYO-20-004
- CYO-20-005
- CYO-20-006
- CYO-20-007

Bottom Perforated

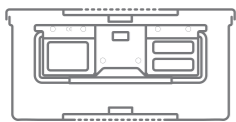

465x280x100mm
2800gr

- CYO-10-011
- CYO-10-012
- CYO-10-013
- CYO-10-014
- CYO-10-015
- CYO-10-016
- CYO-10-017

465x280x135mm
2950gr

- CYO-13-011
- CYO-13-012
- CYO-13-013
- CYO-13-014
- CYO-13-015
- CYO-13-016
- CYO-13-017

465x280x150mm
3050gr.

- CYO-15-011
- CYO-15-012
- CYO-15-013
- CYO-15-014
- CYO-15-015
- CYO-15-016
- CYO-15-017

465x280x200mm
3200gr

- CYO-20-011
- CYO-20-012
- CYO-20-013
- CYO-20-014
- CYO-20-015
- CYO-20-016
- CYO-20-017

Master Series Sterilization Container Systems



Standard Filter System



1/1 Full Size - Büyük Boy

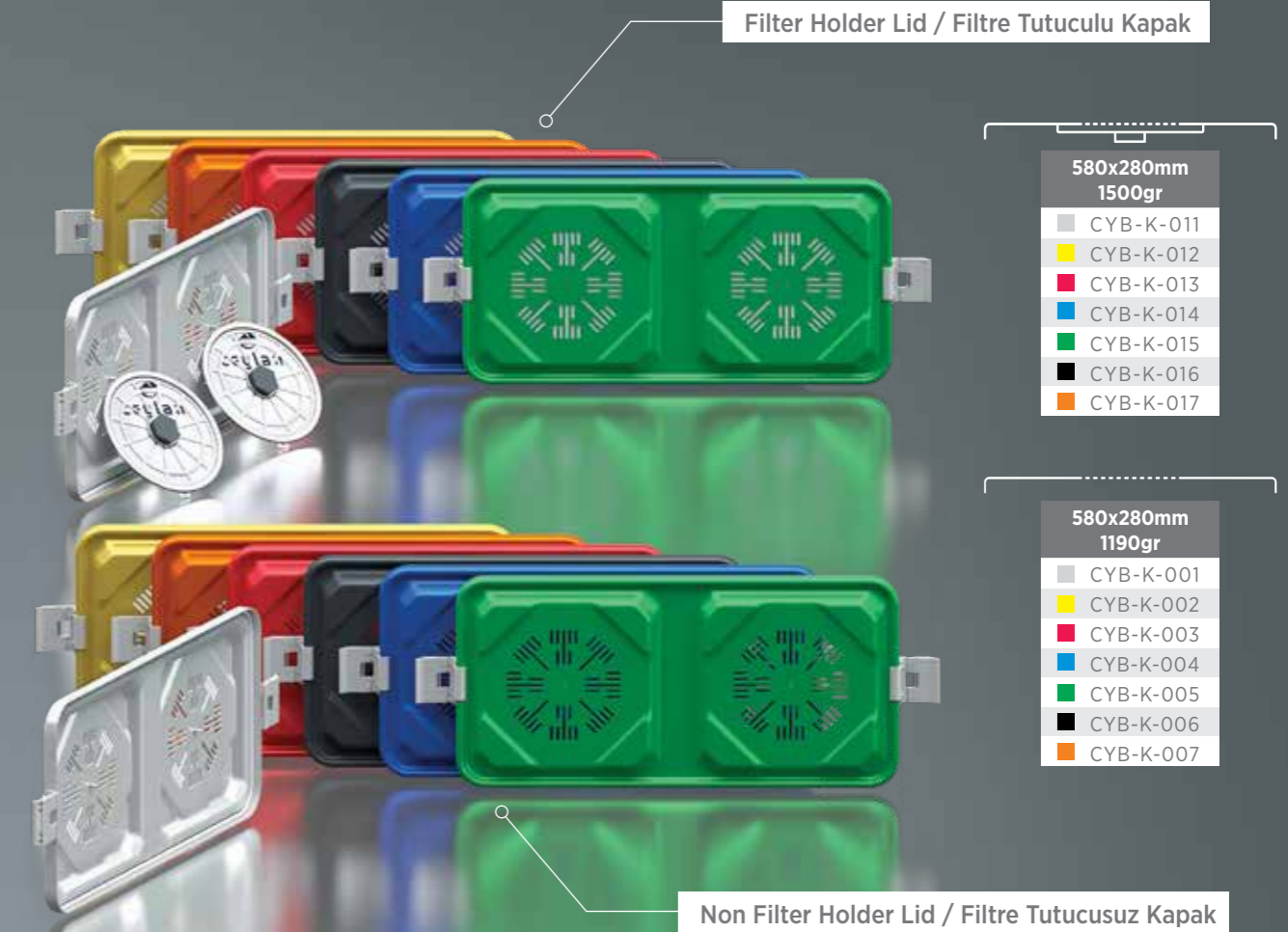

580x280mm
1500gr

- CYB-K-011
- CYB-K-012
- CYB-K-013
- CYB-K-014
- CYB-K-015
- CYB-K-016
- CYB-K-017

580x280mm
1190gr

- CYB-K-001
- CYB-K-002
- CYB-K-003
- CYB-K-004
- CYB-K-005
- CYB-K-006
- CYB-K-007

Non Filter Holder Lid / Filtre Tutucusuz Kapak

SUEDE CHANNEL FILTER SYSTEMS

Bottom Non Perforated

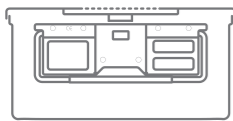

580x280x100mm 3300gr.	580x280x135mm 3600gr.	580x280x150mm 3800gr.	580x280x200mm 4160gr	580x280x260mm 4500gr.
■ CYB-10-001	■ CYB-13-001	■ CYB-15-001	■ CYB-20-001	■ CYB-26-001
■ CYB-10-002	■ CYB-13-002	■ CYB-15-002	■ CYB-20-002	■ CYB-26-002
■ CYB-10-003	■ CYB-13-003	■ CYB-15-003	■ CYB-20-003	■ CYB-26-003
■ CYB-10-004	■ CYB-13-004	■ CYB-15-004	■ CYB-20-004	■ CYB-26-004
■ CYB-10-005	■ CYB-13-005	■ CYB-15-005	■ CYB-20-005	■ CYB-26-005
■ CYB-10-006	■ CYB-13-006	■ CYB-15-006	■ CYB-20-006	■ CYB-26-006
■ CYB-10-007	■ CYB-13-007	■ CYB-15-007	■ CYB-20-007	■ CYB-26-007

Bottom Perforated

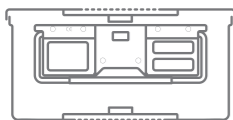

580x280x100mm 3400gr.	580x280x135mm 3920gr	580x280x150mm 4000gr	580x280x200mm 4260gr	580x280x260mm 4600gr
■ CYB-10-011	■ CYB-13-011	■ CYB-15-011	■ CYB-20-011	■ CYB-26-011
■ CYB-10-012	■ CYB-13-012	■ CYB-15-012	■ CYB-20-012	■ CAB-26-012
■ CYB-10-013	■ CYB-13-013	■ CYB-15-013	■ CYB-20-013	■ CYB-26-013
■ CYB-10-014	■ CYB-13-014	■ CYB-15-014	■ CYB-20-014	■ CYB-26-014
■ CYB-10-015	■ CYB-13-015	■ CYB-15-015	■ CYB-20-015	■ CYB-26-015
■ CYB-10-016	■ CYB-13-016	■ CYB-15-016	■ CYB-20-016	■ CYB-26-016
■ CYB-10-017	■ CYB-13-017	■ CYB-15-017	■ CYB-20-017	■ CYB-26-017



Bottom Perforated
Altan Delikli Konteyner

Code	Dimension	Weight
CYB-10-01	580x280x100mm	1900gr.
CYB-13-01	580x280x135mm	2420gr.
CYB-15-01	580x280x150mm	2500gr.
CYB-20-01	580x280x200mm	2760gr.
CYB-26-01	580x280x260mm	3100gr.



Bottom Non Perforated
Altan Deliksiz Konteyner

Code	Dimension	Weight
CYB-10-00	580x280x100mm	1800gr.
CYB-13-00	580x280x135mm	2100gr.
CYB-15-00	580x280x150mm	2300gr.
CYB-20-00	580x280x200mm	2660gr.
CYB-26-00	580x280x260mm	3000gr.

Master Series Sterilization Container Systems



Barrier Valve Filter System



1/2 Half Size - Küçük Boy



285x280mm
930gr

- CAK-BK-001
- CAK-BK-002
- CAK-BK-003
- CAK-BK-004
- CAK-BK-005
- CAK-BK-006
- CAK-BK-007



Bottom Perforated
Altan Delikli Konteyner

Code	Dimension	Weight
CAK-B-10-01	285x280x100mm	2060gr.
CAK-B-13-01	285x280x135mm	2110gr.
CAK-B-15-01	285x280x150mm	2195gr.
CAK-B-20-01	285x280x200mm	2385gr.
CAK-B-26-01	285x280x260mm	2470gr.



Bottom Non Perforated
Altan Deliksiz Konteyner

Code	Dimension	Weight
CAK-10-00	285x280x100mm	1360gr.
CAK-13-00	285x280x135mm	1410gr.
CAK-15-00	285x280x150mm	1490gr.
CAK-20-00	285x280x200mm	1645gr.
CAK-26-00	285x280x260mm	1800gr.

Bottom Non Perforated

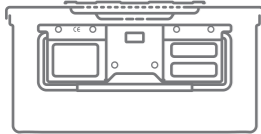

285x280x100mm 2870gr.	285x280x135mm 2940gr.	285x280x150mm 3020gr.	285x280x200mm 3175gr.	285x280x260mm 3300gr.
■ CAK-B-10-001	■ CAK-B-13-001	■ CAK-B-15-001	■ CAK-B-20-001	■ CAK-B-26-001
■ CAK-B-10-002	■ CAK-B-13-002	■ CAK-B-15-002	■ CAK-B-20-002	■ CAK-B-26-002
■ CAK-B-10-003	■ CAK-B-13-003	■ CAK-B-15-003	■ CAK-B-20-003	■ CAK-B-26-003
■ CAK-B-10-004	■ CAK-B-13-004	■ CAK-B-15-004	■ CAK-B-20-004	■ CAK-B-26-004
■ CAK-B-10-005	■ CAK-B-13-005	■ CAK-B-15-005	■ CAK-B-20-005	■ CAK-B-26-005
■ CAK-B-10-006	■ CAK-B-13-006	■ CAK-B-15-006	■ CAK-B-20-006	■ CAK-B-26-006
■ CAK-B-10-007	■ CAK-B-13-007	■ CAK-B-15-007	■ CAK-B-20-007	■ CAK-B-26-007

Bottom Perforated

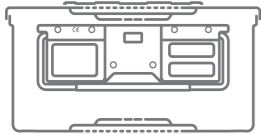

285x280x100mm 2990gr.	285x280x135mm 3040gr.	285x280x150mm 3125gr.	285x280x200mm 3315gr.	285x280x260mm 3400gr.
■ CAK-B-10-011	■ CAK-B-13-011	■ CAK-B-15-011	■ CAK-B-20-011	■ CAK-B-26-011
■ CAK-B-10-012	■ CAK-B-13-012	■ CAK-B-15-012	■ CAK-B-20-012	■ CAK-B-26-012
■ CAK-B-10-013	■ CAK-B-13-013	■ CAK-B-15-013	■ CAK-B-20-013	■ CAK-B-26-013
■ CAK-B-10-014	■ CAK-B-13-014	■ CAK-B-15-014	■ CAK-B-20-014	■ CAK-B-26-014
■ CAK-B-10-015	■ CAK-B-13-015	■ CAK-B-15-015	■ CAK-B-20-015	■ CAK-B-26-015
■ CAK-B-10-016	■ CAK-B-13-016	■ CAK-B-15-016	■ CAK-B-20-016	■ CAK-B-26-016
■ CAK-B-10-017	■ CAK-B-13-017	■ CAK-B-15-017	■ CAK-B-20-017	■ CAK-B-26-017

Master Series Sterilization Container Systems



Barrier Valve Filter System



3/4 Middle Size - Orta Boy



Barrier Lid System / Bariyer Kapaklı Sistem

465x280mm
1100gr.

- CAO-BK-001
- CAO-BK-002
- CAO-BK-003
- CAO-BK-004
- CAO-BK-005
- CAO-BK-006
- CAO-BK-007

Bottom Non Perforated

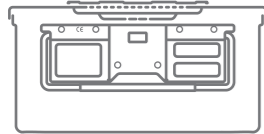

465x280x100mm 3350gr.	465x280x135mm 3500gr.	465x280x150mm 3580gr.	465x280x200mm 3720gr.
CAO-B-10-001	CAO-B-13-001	CAO-B-15-001	CAO-B-20-001
CAO-B-10-002	CAO-B-13-002	CAO-B-15-002	CAO-B-20-002
CAO-B-10-003	CAO-B-13-003	CAO-B-15-003	CAO-B-20-003
CAO-B-10-004	CAO-B-13-004	CAO-B-15-004	CAO-B-20-004
CAO-B-10-005	CAO-B-13-005	CAO-B-15-005	CAO-B-20-005
CAO-B-10-006	CAO-B-13-006	CAO-B-15-006	CAO-B-20-006
CAO-B-10-007	CAO-B-13-007	CAO-B-15-007	CAO-B-20-007

Bottom Perforated

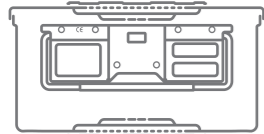

465x280x100mm 3500gr.	465x280x135mm 3650gr.	465x280x150mm 3850gr.	465x280x200mm 4020gr.
CAO-B-10-011	CAO-B-13-011	CAO-B-15-011	CAO-B-20-011
CAO-B-10-012	CAO-B-13-012	CAO-B-15-012	CAO-B-20-012
CAO-B-10-013	CAO-B-13-013	CAO-B-15-013	CAO-B-20-013
CAO-B-10-014	CAO-B-13-014	CAO-B-15-014	CAO-B-20-014
CAO-B-10-015	CAO-B-13-015	CAO-B-15-015	CAO-B-20-015
CAO-B-10-016	CAO-B-13-016	CAO-B-15-016	CAO-B-20-016
CAO-B-10-017	CAO-B-13-017	CAO-B-15-017	CAO-B-20-017



Bottom Perforated
Altan Delikli Konteyner

Code	Dimension	Weight
CAO-B-10-01	465x280x100mm	2320gr.
CAO-B-13-01	465x280x135mm	2470gr.
CAO-B-15-01	465x280x150mm	2670gr.
CAO-B-20-01	465x280x200mm	2840gr.



Bottom Non Perforated
Altan Deliksiz Konteyner

Code	Dimension	Weight
CAO-10-00	465x280x100mm	1550gr.
CAO-13-00	465x280x135mm	1700gr.
CAO-15-00	465x280x150mm	1800gr.
CAO-20-00	465x280x200mm	1950gr.

Master Series Sterilization Container Systems



Barrier Valve Filter System



1/1 Full Size - Büyük Boy

Barrier Lid System / Bariyer Kapaklı Sistem



580x280mm 1780gr.	
■	CAB-BK-001
■	CAB-BK-002
■	CAB-BK-003
■	CAB-BK-004
■	CAB-BK-005
■	CAB-BK-006
■	CAB-BK-007

Bottom Non Perforated

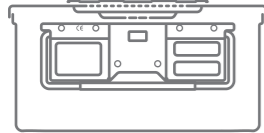

580x280x100mm 4700gr.	580x280x135mm 5000gr.	580x280x150mm 5200gr.	580x280x200mm 5560gr.	580x280x260mm 5900gr.
■ CAB-B-10-001	■ CAB-B-13-001	■ CAB-B-15-001	■ CAB-B-20-001	■ CAB-B-26-001
■ CAB-B-10-002	■ CAB-B-13-002	■ CAB-B-15-002	■ CAB-B-20-002	■ CAB-B-26-002
■ CAB-B-10-003	■ CAB-B-13-003	■ CAB-B-15-003	■ CAB-B-20-003	■ CAB-B-26-003
■ CAB-B-10-004	■ CAB-B-13-004	■ CAB-B-15-004	■ CAB-B-20-004	■ CAB-B-26-004
■ CAB-B-10-005	■ CAB-B-13-005	■ CAB-B-15-005	■ CAB-B-20-005	■ CAB-B-26-005
■ CAB-B-10-006	■ CAB-B-13-006	■ CAB-B-15-006	■ CAB-B-20-006	■ CAB-B-26-006
■ CAB-B-10-007	■ CAB-B-13-007	■ CAB-B-15-007	■ CAB-B-20-007	■ CAB-B-26-007

Bottom Perforated

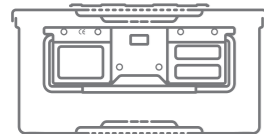

580x280x100mm 4850gr.	580x280x135mm 5320gr.	580x280x150mm 5400gr.	580x280x200mm 5660gr.	580x280x260mm 6070gr.
■ CAB-B-10-011	■ CAB-B-13-011	■ CAB-B-15-011	■ CAB-B-20-011	■ CAB-B-26-011
■ CAB-B-10-012	■ CAB-B-13-012	■ CAB-B-15-012	■ CAB-B-20-012	■ CAB-B-26-012
■ CAB-B-10-013	■ CAB-B-13-013	■ CAB-B-15-013	■ CAB-B-20-013	■ CAB-B-26-013
■ CAB-B-10-014	■ CAB-B-13-014	■ CAB-B-15-014	■ CAB-B-20-014	■ CAB-B-26-014
■ CAB-B-10-015	■ CAB-B-13-015	■ CAB-B-15-015	■ CAB-B-20-015	■ CAB-B-26-015
■ CAB-B-10-016	■ CAB-B-13-016	■ CAB-B-15-016	■ CAB-B-20-016	■ CAB-B-26-016
■ CAB-B-10-017	■ CAB-B-13-017	■ CAB-B-15-017	■ CAB-B-20-017	■ CAB-B-26-017



Bottom Perforated
Altan Delikli Konteyner

Code	Dimension	Weight
CAB-B-10-01	580x280x100mm	3070gr.
CAB-B-13-01	580x280x135mm	3540gr.
CAB-B-15-01	580x280x150mm	3620gr.
CAB-B-20-01	580x280x200mm	3880gr.
CAB-B-26-01	580x280x260mm	4290gr.



Bottom Non Perforated
Altan Deliksiz Konteyner

Code	Dimension	Weight
CAB-10-00	580x280x100mm	1800gr.
CAB-13-00	580x280x135mm	2100gr.
CAB-15-00	580x280x150mm	2300gr.
CAB-20-00	580x280x200mm	2660gr.
CAB-26-00	580x280x260mm	3000gr.

Master Series Sterilization Container Systems



Safe Guardian System



1/2 Half Size - Küçük Boy



285x280mm 1340gr.	
■	CAK-K-111
■	CAK-K-112
■	CAK-K-113
■	CAK-K-114
■	CAK-K-115
■	CAK-K-116
■	CAK-K-117

Bottom Non Perforated

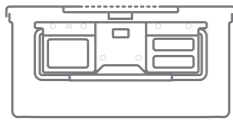

285x280x100mm 3119gr.	285x280x135mm 3240gr.	285x280x150mm 3320gr.	285x280x200mm 34750gr.	285x280x260mm 3600gr.
■ CAK-10-101	■ CAK-13-101	■ CAK-15-101	■ CAK-20-101	■ CAK-26-101
■ CAK-10-102	■ CAK-13-102	■ CAK-15-102	■ CAK-20-102	■ CAK-26-102
■ CAK-10-103	■ CAK-13-103	■ CAK-15-103	■ CAK-20-103	■ CAK-26-103
■ CAK-10-104	■ CAK-13-104	■ CAK-15-104	■ CAK-20-104	■ CAK-26-104
■ CAK-10-105	■ CAK-13-105	■ CAK-15-105	■ CAK-20-105	■ CAK-26-105
■ CAK-10-106	■ CAK-13-106	■ CAK-15-106	■ CAK-20-106	■ CAK-26-106
■ CAK-10-107	■ CAK-13-107	■ CAK-15-107	■ CAK-20-107	■ CAK-26-107

Bottom Perforated

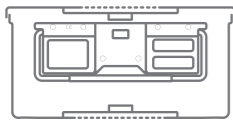

285x280x100mm 3290gr	285x280x135mm 3340gr.	285x280x150mm 3425gr.	285x280x200mm 3615gr.	285x280x260mm 3700gr.
■ CAK-10-111	■ CAK-13-111	■ CAK-15-111	■ CAK-20-111	■ CAK-26-111
■ CAK-10-112	■ CAK-13-112	■ CAK-15-112	■ CAK-20-112	■ CAK-26-112
■ CAK-10-113	■ CAK-13-113	■ CAK-15-113	■ CAK-20-113	■ CAK-26-113
■ CAK-10-114	■ CAK-13-114	■ CAK-15-114	■ CAK-20-114	■ CAK-26-114
■ CAK-10-115	■ CAK-13-115	■ CAK-15-115	■ CAK-20-115	■ CAK-26-115
■ CAK-10-116	■ CAK-13-116	■ CAK-15-116	■ CAK-20-116	■ CAK-26-116
■ CAK-10-117	■ CAK-13-117	■ CAK-15-117	■ CAK-20-117	■ CAK-26-117



Bottom Perforated
Altan Delikli Konteyner

Code	Dimension	Weight
CAK-10-01	285x280x100mm	1460gr.
CAK-13-01	285x280x135mm	1510gr.
CAK-15-01	285x280x150mm	1595gr.
CAK-20-01	285x280x200mm	1785gr.
CAK-26-01	285x280x260mm	1920gr.



Bottom Non Perforated
Altan Deliksiz Konteyner

Code	Dimension	Weight
CAK-10-00	285x280x100mm	1360gr.
CAK-13-00	285x280x135mm	1410gr.
CAK-15-00	285x280x150mm	1490gr.
CAK-20-00	285x280x200mm	1645gr.
CAK-26-00	285x280x260mm	1800gr.

Master Series Sterilization Container Systems



Safe Guardian System



3/4 Middle Size - Orta Boy

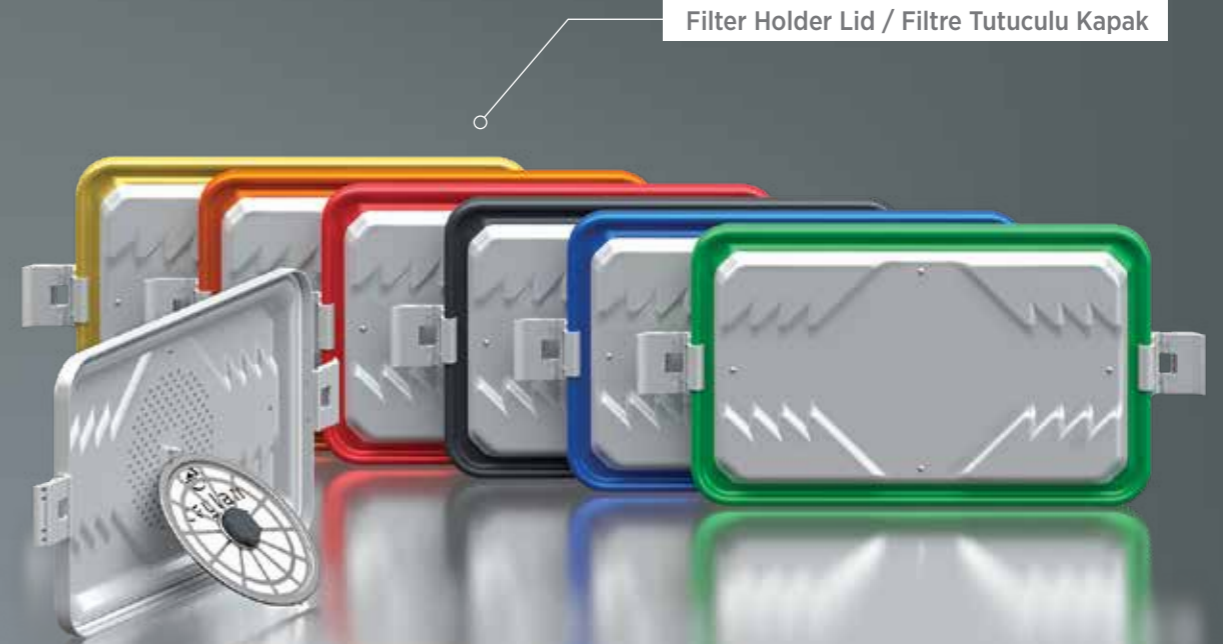

465x280mm
1100gr.

- CAO-K-111
- CAO-K-112
- CAO-K-113
- CAO-K-114
- CAO-K-115
- CAO-K-116
- CAO-K-117



Bottom Perforated
Altan Delikli Konteyner

Code	Dimension	Weight
CAO-10-01	465x280x100mm	1700gr.
CAO-13-01	465x280x135mm	1850gr.
CAO-15-01	465x280x150mm	1950gr.
CAO-20-01	465x280x200mm	2100gr.



Bottom Non Perforated
Altan Deliksiz Konteyner

Code	Dimension	Weight
CAO-10-00	465x280x100mm	1550gr.
CAO-13-00	465x280x135mm	1700gr.
CAO-15-00	465x280x150mm	1800gr.
CAO-20-00	465x280x200mm	1950gr.

Bottom Non Perforated

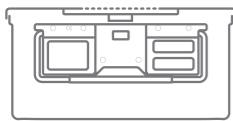

465x280x100mm 3650gr.	465x280x135mm 3800gr.	465x280x150mm 3890gr.	465x280x200mm 4200gr.
■ CAO-10-101	■ CAO-13-101	■ CAO-15-101	■ CAO-20-101
■ CAO-10-102	■ CAO-13-102	■ CAO-15-102	■ CAO-20-102
■ CAO-10-103	■ CAK-13-103	■ CAO-15-103	■ CAO-20-103
■ CAO-10-104	■ CAO-13-104	■ CAO-15-104	■ CAO-20-104
■ CAO-10-105	■ CAO-13-105	■ CAO-15-105	■ CAO-20-105
■ CAO-10-106	■ CAK-13-106	■ CAO-15-106	■ CAO-20-106
■ CAO-10-107	■ CAO-13-107	■ CAO-15-107	■ CAO-20-107

Bottom Perforated

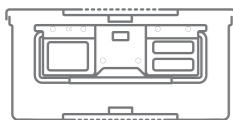

465x280x100mm 3800gr.	465x280x135mm 3950gr.	465x280x150mm 4150gr.	465x280x200mm 4300gr.
■ CAO-10-111	■ CKO-13-111	■ CAO-15-111	■ CAO-20-111
■ CAO-10-112	■ CAO-13-112	■ CAO-15-112	■ CAO-20-112
■ CAO-10-113	■ CAO-13-113	■ CAO-15-113	■ CAO-20-113
■ CAO-10-114	■ CAO-13-114	■ CAO-15-114	■ CAO-20-114
■ CAO-10-115	■ CAO-13-115	■ CAO-15-115	■ CAO-20-115
■ CAO-10-116	■ CAO-13-116	■ CAO-15-116	■ CAO-20-116
■ CAO-10-117	■ CAO-13-117	■ CAO-15-117	■ CAO-20-117

Master Series Sterilization Container Systems



Safe Guardian System



Bottom Non Perforated

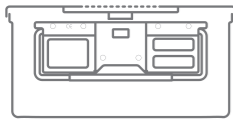

580x280x100mm 5300gr.	580x280x135mm 5600gr.	580x280x150mm 5800gr.	580x280x200mm 6160gr.	580x280x260mm 6450gr.
■ CAB-10-101	■ CAB-13-101	■ CAB-15-101	■ CAB-20-101	■ CAB-26-101
■ CAB-10-102	■ CAB-13-102	■ CAB-15-102	■ CAB-20-102	■ CAB-26-102
■ CAB-10-103	■ CAB-13-103	■ CAB-15-103	■ CAB-20-103	■ CAB-26-103
■ CAB-10-104	■ CAB-13-104	■ CAB-15-104	■ CAB-20-104	■ CAB-26-104
■ CAB-10-105	■ CAB-13-105	■ CAB-15-105	■ CAB-20-105	■ CAB-26-105
■ CAB-10-106	■ CAB-13-106	■ CAB-15-106	■ CAB-20-106	■ CAB-26-106
■ CAB-10-107	■ CAB-13-107	■ CAB-15-107	■ CAB-20-107	■ CAB-26-107

Bottom Perforated

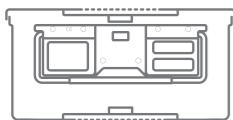

580x280x100mm 5400gr.	580x280x135mm 5920gr.	580x280x150mm 6000gr.	580x280x200mm 6260gr.	580x280x260mm 6630gr.
■ CAB-10-111	■ CAB-13-111	■ CAB-15-111	■ CAB-20-111	■ CAB-26-111
■ CAB-10-112	■ CAB-13-112	■ CAB-15-112	■ CAB-20-112	■ CAB-26-112
■ CAB-10-113	■ CAB-13-113	■ CAB-15-113	■ CAB-20-113	■ CAB-26-113
■ CAB-10-114	■ CAB-13-114	■ CAB-15-114	■ CAB-20-114	■ CAB-26-114
■ CAB-10-115	■ CAB-13-115	■ CAB-15-115	■ CAB-20-115	■ CAB-26-115
■ CAB-10-116	■ CAB-13-116	■ CAB-15-116	■ CAB-20-116	■ CAB-26-116
■ CAB-10-117	■ CAB-13-117	■ CAB-15-117	■ CAB-20-117	■ CAB-26-117

1/1 Full Size - Büyük Boy

Filter Holder Lid / Filtre Tutuculu Kapak



580x280mm
1500gr.

■ CAB-K-111
■ CAB-K-112
■ CAB-K-113
■ CAB-K-114
■ CAB-K-115
■ CAB-K-116
■ CAB-K-117



Bottom Perforated
Altan Delikli Konteyner

Code	Dimension	Weight
CAB-10-01	580x280x100mm	1900gr.
CAB-13-01	580x280x135mm	2420gr.
CAB-15-01	580x280x150mm	2500gr.
CAB-20-01	580x280x200mm	2760gr.
CAB-26-01	580x280x260mm	3100gr.



Bottom Non Perforated
Altan Deliksiz Konteyner

Code	Dimension	Weight
CAB-10-00	580x280x100mm	1800gr.
CAB-13-00	580x280x135mm	2100gr.
CAB-15-00	580x280x150mm	2300gr.
CAB-20-00	580x280x200mm	2660gr.
CAB-26-00	580x280x260mm	3000gr.

Master Series Sterilization Container Systems



Dismountable Barrier Filter System



1/2 Half Size - Küçük Boy



285x280mm 930gr.	
■	CAK-BK1-001
■	CAK-BK1-002
■	CAK-BK1-003
■	CAK-BK1-004
■	CAK-BK1-005
■	CAK-BK1-006
■	CAK-BK1-007

Bottom Non Perforated

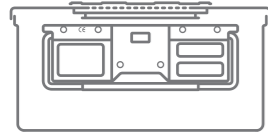

285x280x100mm 2870gr.	285x280x135mm 2940gr.	285x280x150mm 3020gr.	285x280x200mm 3175gr.	285x280x260mm 3300gr.
■ CAK-B1-10-001	■ CAK-B1-13-001	■ CAK-B1-15-001	■ CAK-B1-20-001	■ CAK-B1-26-001
■ CAK-B1-10-002	■ CAK-B1-13-002	■ CAK-B1-15-002	■ CAK-B1-20-002	■ CAK-B1-26-002
■ CAK-B1-10-003	■ CAK-B1-13-003	■ CAK-B1-15-003	■ CAK-B1-20-003	■ CAK-B1-26-003
■ CAK-B1-10-004	■ CAK-B1-13-004	■ CAK-B1-15-004	■ CAK-B1-20-004	■ CAK-B1-26-004
■ CAK-B1-10-005	■ CAK-B1-13-005	■ CAK-B1-15-005	■ CAK-B1-20-005	■ CAK-B1-26-005
■ CAK-B1-10-006	■ CAK-B1-13-006	■ CAK-B1-15-006	■ CAK-B1-20-006	■ CAK-B1-26-006
■ CAK-B1-10-007	■ CAK-B1-13-007	■ CAK-B1-15-007	■ CAK-B1-20-007	■ CAK-B1-26-007

Bottom Perforated

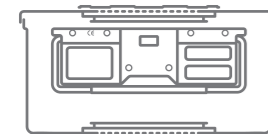

285x280x100mm 2990gr.	285x280x135mm 3040gr.	285x280x150mm 3125gr.	285x280x200mm 3315gr.	285x280x260mm 3400gr.
■ CAK-B1-10-011	■ CAK-B1-13-011	■ CAK-B1-15-011	■ CAK-B1-20-011	■ CAK-B1-26-011
■ CAK-B1-10-012	■ CAK-B1-13-012	■ CAK-B1-15-012	■ CAK-B1-20-012	■ CAK-B1-26-012
■ CAK-B1-10-013	■ CAK-B1-13-013	■ CAK-B1-15-013	■ CAK-B1-20-013	■ CAK-B1-26-013
■ CAK-B1-10-014	■ CAK-B1-13-014	■ CAK-B1-15-014	■ CAK-B1-20-014	■ CAK-B1-26-014
■ CAK-B1-10-015	■ CAK-B1-13-015	■ CAK-B1-15-015	■ CAK-B1-20-015	■ CAK-B1-26-015
■ CAK-B1-10-016	■ CAK-B1-13-016	■ CAK-B1-15-016	■ CAK-B1-20-016	■ CAK-B1-26-016
■ CAK-B1-10-017	■ CAK-B1-13-017	■ CAK-B1-15-017	■ CAK-B1-20-017	■ CAK-B1-26-017



Bottom Perforated
Altan Delikli Konteyner

Code	Dimension	Weight
CAK-B1-10-01	285x280x100mm	2060gr.
CAK-B1-13-01	285x280x135mm	2110gr.
CAK-B1-15-01	285x280x150mm	2195gr.
CAK-B1-20-01	285x280x200mm	2385gr.
CAK-B1-26-01	285x280x260mm	2470gr.



Bottom Non Perforated
Altan Deliksiz Konteyner

Code	Dimension	Weight
CAK-10-00	285x280x100mm	1360gr.
CAK-13-00	285x280x135mm	1410gr.
CAK-15-00	285x280x150mm	1490gr.
CAK-20-00	285x280x200mm	1645gr.
CAK-26-00	285x280x260mm	1800gr.

Master Series Sterilization Container Systems



Dismountable Barrier Filter System



3/4 Middle Size - Orta Boy



465x280mm
1180gr

- CAO-BK1-001
- CAO-BK1-002
- CAO-BK1-003
- CAO-BK1-004
- CAO-BK1-005
- CAO-BK1-006
- CAO-BK1-007

Bottom Non Perforated

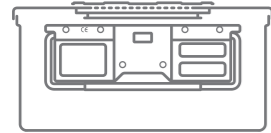

465x280x100mm
3350gr.

- CAO-B1-10-001
- CAO-B1-10-002
- CAO-B1-10-003
- CAO-B1-10-004
- CAO-B1-10-005
- CAO-B1-10-006
- CAO-B1-10-007

465x280x135mm
3500gr.

- CAO-B1-13-001
- CAO-B1-13-002
- CAO-B1-13-003
- CAO-B1-13-004
- CAO-B1-13-005
- CAO-B1-13-006
- CAO-B1-13-007

465x280x150mm
3580gr.

- CAO-B1-15-001
- CAO-B1-15-002
- CAO-B1-15-003
- CAO-B1-15-004
- CAO-B1-15-005
- CAO-B1-15-006
- CAO-B1-15-007

465x280x200mm
3720gr.

- CAO-B1-20-001
- CAO-B1-20-002
- CAO-B1-20-003
- CAO-B1-20-004
- CAO-B1-20-005
- CAO-B1-20-006
- CAO-B1-20-007

Bottom Perforated

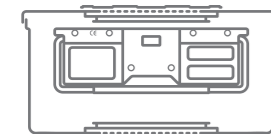

465x280x100mm
3500gr.

- CAO-B1-10-011
- CAO-B1-10-012
- CAO-B1-10-013
- CAO-B1-10-014
- CAO-B1-10-015
- CAO-B1-10-016
- CAO-B1-10-017

465x280x135mm
3650gr.

- CAO-B1-13-011
- CAO-B1-13-012
- CAO-B1-13-013
- CAO-B1-13-014
- CAO-B1-13-015
- CAO-B1-13-016
- CAO-B1-13-017

465x280x150mm
3850gr.

- CAO-B1-15-011
- CAO-B1-15-012
- CAO-B1-15-013
- CAO-B1-15-014
- CAO-B1-15-015
- CAO-B1-15-016
- CAO-B1-15-017

465x280x200mm
4020gr.

- CAO-B1-20-011
- CAO-B1-20-012
- CAO-B1-20-013
- CAO-B1-20-014
- CAO-B1-20-015
- CAO-B1-20-016
- CAO-B1-20-017



Bottom Perforated
Altan Delikli Konteyner

Code	Dimension	Weight
CAO-B1-10-01	465x280x100mm	2320gr.
CAO-B1-13-01	465x280x135mm	2470gr.
CAO-B1-15-01	465x280x150mm	2670gr.
CAO-B1-20-01	465x280x200mm	2840gr.



Bottom Non Perforated
Altan Deliksiz Konteyner

Code	Dimension	Weight
CAO-10-00	465x280x100mm	1550gr.
CAO-13-00	465x280x135mm	1700gr.
CAO-15-00	465x280x150mm	1800gr.
CAO-20-00	465x280x200mm	1950gr.

Master Series Sterilization Container Systems



Dismountable Barrier Filter System



1/1 Full Size - Büyük Boy



580x280mm
1780gr.

- CAB-BK1-001
- CAB-BK1-002
- CAB-BK1-003
- CAB-BK1-004
- CAB-BK1-005
- CAB-BK1-006
- CAB-BK1-007

Bottom Non Perforated

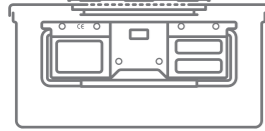

580x280x100mm 4700gr.	580x280x135mm 5000gr.	580x280x150mm 5200gr.	580x280x200mm 5560gr.	580x280x260mm 5900gr.
■ CAB-B1-10-001	■ CAB-B1-13-001	■ CAB-B1-15-001	■ CAB-B1-20-001	■ CAB-B1-26-001
■ CAB-B1-10-002	■ CAB-B1-13-002	■ CAB-B1-15-002	■ CAB-B1-20-002	■ CAB-B1-26-002
■ CAB-B1-10-003	■ CAB-B1-13-003	■ CAB-B1-15-003	■ CAB-B1-20-003	■ CAB-B1-26-003
■ CAB-B1-10-004	■ CAB-B1-13-004	■ CAB-B1-15-004	■ CAB-B1-20-004	■ CAB-B1-26-004
■ CAB-B1-10-005	■ CAB-B1-13-005	■ CAB-B1-15-005	■ CAB-B1-20-005	■ CAB-B1-26-005
■ CAB-B1-10-006	■ CAB-B1-13-006	■ CAB-B1-15-006	■ CAB-B1-20-006	■ CAB-B1-26-006
■ CAB-B1-10-007	■ CAB-B1-13-007	■ CAB-B1-15-007	■ CAB-B1-20-007	■ CAB-B1-26-007

Bottom Perforated

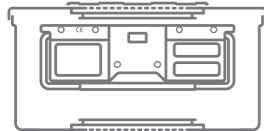

580x280x100mm 4850gr.	580x280x135mm 5320gr.	580x280x150mm 5400gr.	580x280x200mm 5660gr.	580x280x260mm 6070gr.
■ CAB-B1-10-011	■ CAB-B1-13-011	■ CAB-B1-15-011	■ CAB-B1-20-011	■ CAB-B1-26-011
■ CAB-B1-10-012	■ CAB-B1-13-012	■ CAB-B1-15-012	■ CAB-B1-20-012	■ CAB-B1-26-012
■ CAB-B1-10-013	■ CAB-B1-13-013	■ CAB-B1-15-013	■ CAB-B1-20-013	■ CAB-B1-26-013
■ CAB-B1-10-014	■ CAB-B1-13-014	■ CAB-B1-15-014	■ CAB-B1-20-014	■ CAB-B1-26-014
■ CAB-B1-10-015	■ CAB-B1-13-015	■ CAB-B1-15-015	■ CAB-B1-20-015	■ CAB-B1-26-015
■ CAB-B1-10-016	■ CAB-B1-13-016	■ CAB-B1-15-016	■ CAB-B1-20-016	■ CAB-B1-26-016
■ CAB-B1-10-017	■ CAB-B1-13-017	■ CAB-B1-15-017	■ CAB-B1-20-017	■ CAB-B1-26-017



Bottom Perforated
Altan Delikli Konteyner

Code	Dimension	Weight
CAB-B1-10-01	580x280x100mm	3070gr.
CAB-B1-13-01	580x280x135mm	3540gr.
CAB-B1-15-01	580x280x150mm	3620gr.
CAB-B1-20-01	580x280x200mm	3880gr.
CAB-B1-26-01	580x280x260mm	4290gr.



Bottom Non Perforated
Altan Deliksiz Konteyner

Code	Dimension	Weight
CAB-10-00	580x280x100mm	1800gr.
CAB-13-00	580x280x135mm	2100gr.
CAB-15-00	580x280x150mm	2300gr.
CAB-20-00	580x280x200mm	2660gr.
CAB-26-00	580x280x260mm	3000gr.

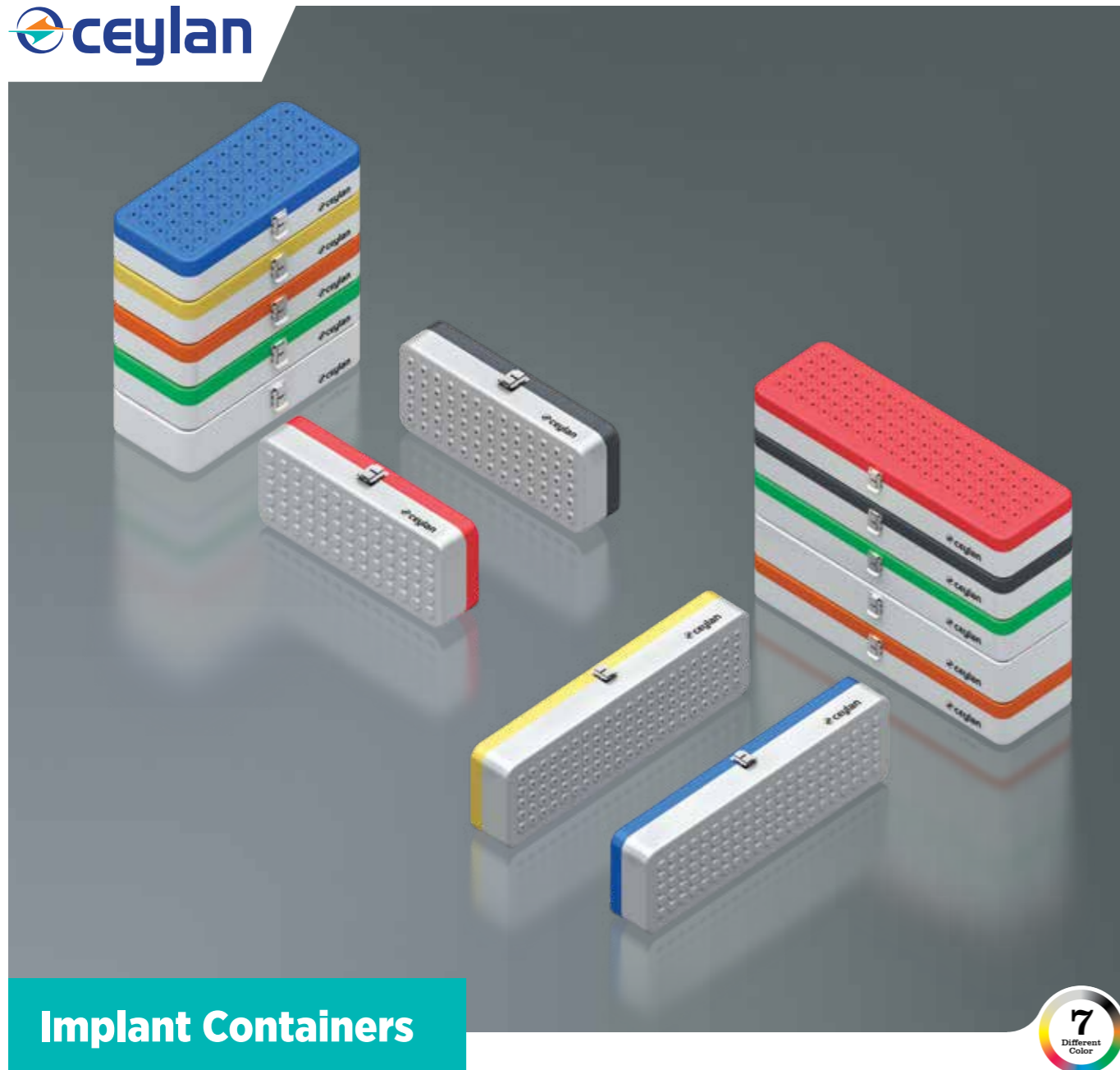

Implant Containers

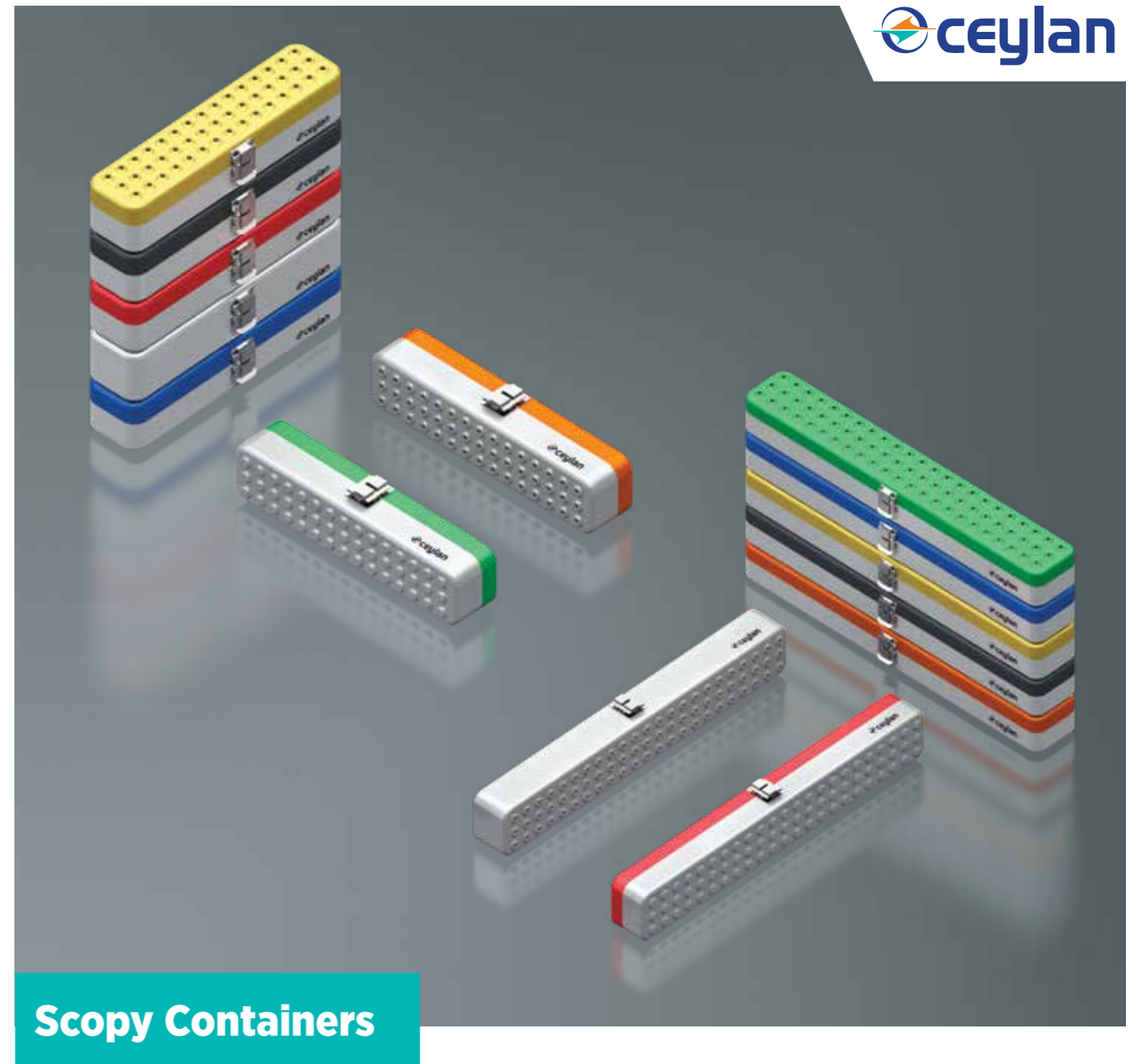

Scopy Containers

Bottom Non Perforated

310x138x65mm

- CKI-06-001
- CKI-06-002
- CKI-06-003
- CKI-06-004
- CKI-06-005
- CKI-06-006
- CKI-06-007



Bottom Perforated

310x138x65mm

- CKI-06-011
- CKI-06-012
- CKI-06-013
- CKI-06-014
- CKI-06-015
- CKI-06-016
- CKI-06-017



Bottom Non Perforated

500x155x75mm

- CKI-07-001
- CKI-07-002
- CKI-07-003
- CKI-07-004
- CKI-07-005
- CKI-07-006
- CKI-07-007



Bottom Perforated

500x155x75mm

- CKI-07-011
- CKI-07-012
- CKI-07-013
- CKI-07-014
- CKI-07-015
- CKI-07-016
- CKI-07-017



Bottom Non Perforated

250x60x50mm

- CKS-05-001
- CKS-05-002
- CKS-05-003
- CKS-05-004
- CKS-05-005
- CKS-05-006
- CKS-05-007



Bottom Perforated

250x60x50mm

- CKS-05-011
- CKS-05-012
- CKS-05-013
- CKS-05-014
- CKS-05-015
- CKS-05-016
- CKS-05-017

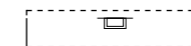

Bottom Non Perforated

450x70x70mm

- CKS-07-001
- CKS-07-002
- CKS-07-003
- CKS-07-004
- CKS-07-005
- CKS-07-006
- CKS-07-007



Bottom Perforated

450x70x70mm

- CKS-07-011
- CKS-07-012
- CKS-07-013
- CKS-07-014
- CKS-07-015
- CKS-07-016
- CKS-07-017

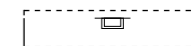



Anodized Sheet Metal Baskets

With Lid

Without Lid



255x245x40mm		255x245x60mm		255x245x40mm		255x245x60mm	
CSK-04-011	CSK-04-012	CSK-06-011	CSK-06-012	CSK-04-01	CSK-04-02	CSK-06-01	CSK-06-02
CSK-04-013	CSK-04-014	CSK-06-013	CSK-06-014	CSK-04-03	CSK-04-04	CSK-06-03	CSK-06-04
CSK-04-015	CSK-04-016	CSK-06-015	CSK-06-016	CSK-04-05	CSK-04-06	CSK-06-05	CSK-06-06
CSK-04-017		CSK-06-017		CSK-04-07		CSK-06-07	

255x245x80mm		255x245x100mm		255x245x40mm		255x245x60mm	
CSK-08-011	CSK-08-012	CSK-10-011	CSK-10-012	CSK-08-01	CSK-08-02	CSK-10-01	CSK-10-02
CSK-08-013	CSK-08-014	CSK-10-013	CSK-10-014	CSK-08-03	CSK-08-04	CSK-10-03	CSK-10-04
CSK-08-015	CSK-08-016	CSK-10-015	CSK-10-016	CSK-08-05	CSK-08-06	CSK-10-05	CSK-10-06
CSK-08-017		CSK-10-017		CSK-08-07		CSK-10-07	

With Lid

Without Lid



405x245x40mm		405x245x60mm		405x245x40mm		405x245x60mm	
CSO-04-011	CSO-04-012	CSO-06-011	CSO-06-012	CSO-04-01	CSO-04-02	CSO-06-01	CSO-06-02
CSO-04-013	CSO-04-014	CSO-06-013	CSO-06-014	CSO-04-03	CSO-04-04	CSO-06-03	CSO-06-04
CSO-04-015	CSO-04-016	CSO-06-015	CSO-06-016	CSO-04-05	CSO-04-06	CSO-06-05	CSO-06-06
CSO-04-017		CSO-06-017		CSO-04-07		CSO-06-07	

405x245x80mm		405x245x100mm		405x245x80mm		405x245x100mm	
CSO-08-011	CSO-08-012	CSO-10-011	CSO-10-012	CSO-08-01	CSO-08-02	CSO-10-01	CSO-10-02
CSO-08-013	CSO-08-014	CSO-10-013	CSO-10-014	CSO-08-03	CSO-08-04	CSO-10-03	CSO-10-04
CSO-08-015	CSO-08-016	CSO-10-015	CSO-10-016	CSO-08-05	CSO-08-06	CSO-10-05	CSO-10-06
CSO-08-017		CSO-10-017		CSO-08-07		CSO-10-07	

With Lid

Without Lid

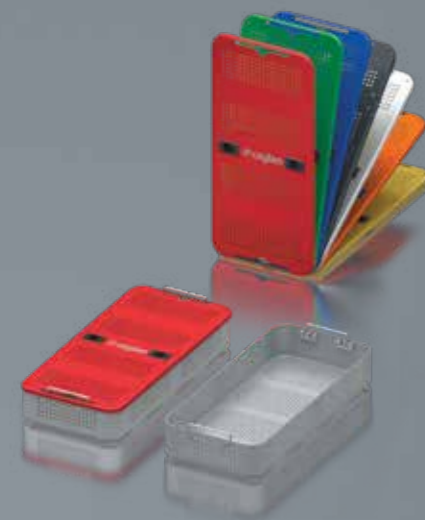

540x245x40mm		540x245x60mm		540x245x40mm		540x245x60mm	
CSB-04-011	CSB-04-012	CSB-06-011	CSB-06-012	CSB-04-01	CSB-04-02	CSB-06-01	CSB-06-02
CSB-04-013	CSB-04-014	CSB-06-013	CSB-06-014	CSB-04-03	CSB-04-04	CSB-06-03	CSB-06-04
CSB-04-015	CSB-04-016	CSB-06-015	CSB-06-016	CSB-04-05	CSB-04-06	CSB-06-05	CSB-06-06
CSB-04-017		CSB-06-017		CSB-04-07		CSB-06-07	

540x245x80mm		540x245x100mm		540x245x80mm		540x245x100mm	
CSB-08-011	CSB-08-012	CSB-10-011	CSB-10-012	CSB-08-01	CSB-08-02	CSB-10-01	CSB-10-02
CSB-08-013	CSB-08-014	CSB-10-013	CSB-10-014	CSB-08-03	CSB-08-04	CSB-10-03	CSB-10-04
CSB-08-015	CSB-08-016	CSB-10-015	CSB-10-016	CSB-08-05	CSB-08-06	CSB-10-05	CSB-10-06
CSB-08-017		CSB-10-017		CSB-08-07		CSB-10-07	

Orthopaedic Trays

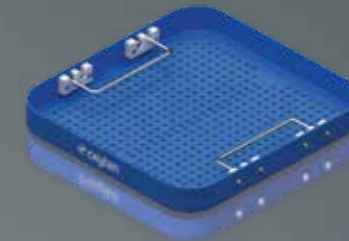
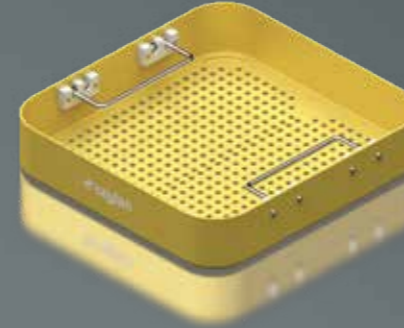

255x245x30mm		255x245x50mm	
CKT-03-01	CKT-03-02	CKT-05-01	CKT-05-02
CKT-03-03	CKT-03-04	CKT-05-03	CKT-05-04
CKT-03-05	CKT-03-06	CKT-05-05	CKT-05-06
CKT-03-07		CKT-05-07	

255x245x70mm		255x245x100mm	
CKT-07-01	CKT-07-02	CKT-10-01	CKT-10-02
CKT-07-03	CKT-07-04	CKT-10-03	CKT-10-04
CKT-07-05	CKT-07-06	CKT-10-05	CKT-10-06
CKT-07-07		CKT-10-07	

405x255x30mm		405x255x50mm	
COT-03-01	COT-03-02	COT-05-01	COT-05-02
COT-03-03	COT-03-04	COT-05-03	COT-05-04
COT-03-05	COT-03-06	COT-05-05	COT-05-06
COT-03-07		COT-05-07	

405x255x70mm		405x255x100mm	
COT-07-01	COT-07-02	COT-10-01	COT-10-02
COT-07-03	COT-07-04	COT-10-03	COT-10-04
COT-07-05	COT-07-06	COT-10-05	COT-10-06
COT-07-07		COT-10-07	

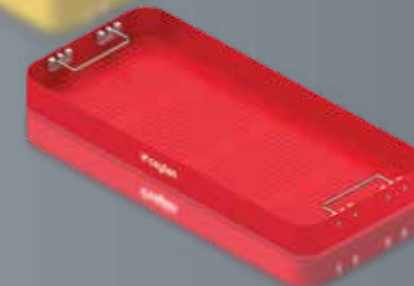
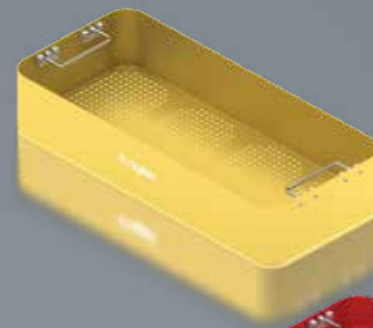

540x255x30mm		540x255x50mm	
CBT-03-01	CBT-03-02	CBT-05-01	CBT-05-02
CBT-03-03	CBT-03-04	CBT-05-03	CBT-05-04
CBT-03-05	CBT-03-06	CBT-05-05	CBT-05-06
CBT-03-07		CBT-05-07	

540x255x70mm		540x255x100mm	
CBT-07-01	CBT-07-02	CBT-10-01	CBT-10-02
CBT-07-03	CBT-07-04	CBT-10-03	CBT-10-04
CBT-07-05	CBT-07-06	CBT-10-05	CBT-10-06
CBT-07-07		CBT-10-07	

Dental Containers Standard Filter System

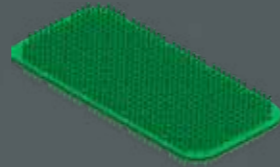

Silicone Mat
CSC-28-016 280 x 160 mm

Bottom Non Perforated

310x190x130mm	310x190x100mm
CKD-13-001	CKD-10-001
CKD-13-002	CKD-10-002
CKD-13-003	CKD-10-003
CKD-13-004	CKD-10-004
CKD-13-005	CKD-10-005
CKD-13-006	CKD-10-006
CKD-13-007	CKD-10-007



Bottom Perforated

310x190x130mm	310x190x100mm
CKD-13-011	CKD-10-011
CKD-13-012	CKD-10-012
CKD-13-013	CKD-10-013
CKD-13-014	CKD-10-014
CKD-13-015	CKD-10-015
CKD-13-016	CKD-10-016
CKD-13-017	CKD-10-017

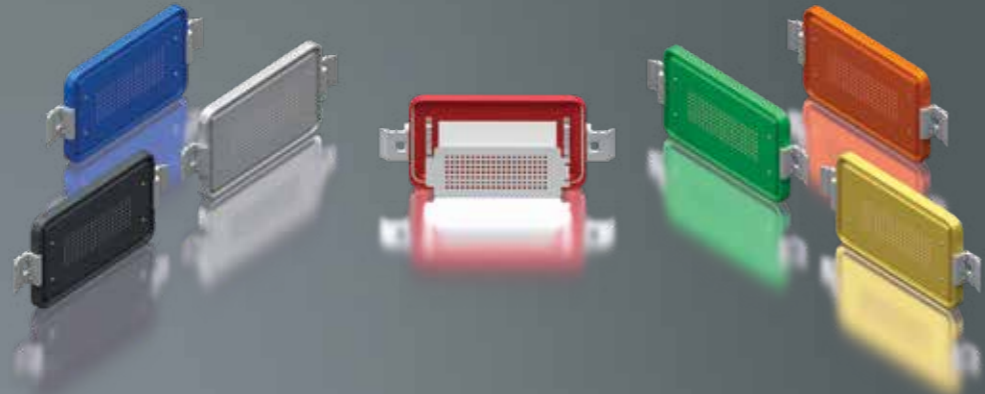

Bottom Non Perforated

310x190x60mm	310x190x40mm
CKD-06-001	CKD-04-001
CKD-06-002	CKD-04-002
CKD-06-003	CKD-04-003
CKD-06-004	CKD-04-004
CKD-06-005	CKD-04-005
CKD-06-006	CKD-04-006
CKD-06-007	CKD-04-007



Bottom Perforated

310x190x60mm	310x190x40mm
CKD-06-011	CKD-04-011
CKD-06-012	CKD-04-012
CKD-06-013	CKD-04-013
CKD-06-014	CKD-04-014
CKD-06-015	CKD-04-015
CKD-06-016	CKD-04-016
CKD-06-017	CKD-04-017

Barrier Filter System



Bottom Non Perforated

310x190x100mm	310x190x130mm
CKD-B-10-001	CKD-B-13-001
CKD-B-10-002	CKD-B-13-002
CKD-B-10-003	CKD-B-13-003
CKD-B-10-004	CKD-B-13-004
CKD-B-10-005	CKD-B-13-005
CKD-B-10-006	CKD-B-13-006
CKD-B-10-007	CKD-B-13-007



Bottom Perforated

310x190x100mm	310x190x130mm
CKD-B-10-011	CKD-B-13-011
CKD-B-10-012	CKD-B-13-012
CKD-B-10-013	CKD-B-13-013
CKD-B-10-014	CKD-B-13-014
CKD-B-10-015	CKD-B-13-015
CKD-B-10-016	CKD-B-13-016
CKD-B-10-017	CKD-B-13-017



Bottom Non Perforated

310x190x40mm	310x190x60mm
CKD-B-04-001	CKD-B-06-001
CKD-B-04-002	CKD-B-06-002
CKD-B-04-003	CKD-B-06-003
CKD-B-04-004	CKD-B-06-004
CKD-B-04-005	CKD-B-06-005
CKD-B-04-006	CKD-B-06-006
CKD-B-04-007	CKD-B-06-007



Bottom Perforated

310x190x40mm	310x190x60mm
CKD-B-04-011	CKD-B-06-011
CKD-B-04-012	CKD-B-06-012
CKD-B-04-013	CKD-B-06-013
CKD-B-04-014	CKD-B-06-014
CKD-B-04-015	CKD-B-06-015
CKD-B-04-016	CKD-B-06-016
CKD-B-04-017	CKD-B-06-017

Mini Containers Standard Filter System

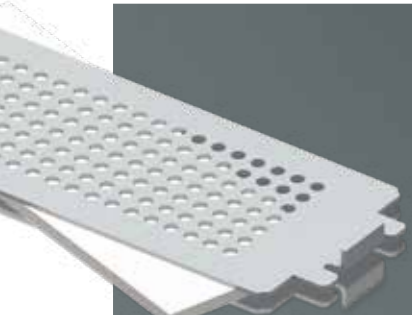

Bottom Non Perforated Bottom Perforated

300x140x40mm		300x140x40mm	
CKM-04-001	CKM-04-011	CKM-04-002	CKM-04-012
CKM-04-003	CKM-04-013	CKM-04-004	CKM-04-014
CKM-04-005	CKM-04-015	CKM-04-006	CKM-04-016
CKM-04-007	CKM-04-017		

Bottom Non Perforated Bottom Perforated

300x140x70mm		300x140x70mm	
CKM-07-001	CKM-07-011	CKM-07-002	CKM-07-012
CKM-07-003	CKM-07-013	CKM-07-004	CKM-07-014
CKM-07-005	CKM-07-015	CKM-07-006	CKM-07-016
CKM-07-007	CKM-07-017		

Bottom Non Perforated Bottom Perforated

300x140x100mm		300x140x100mm	
CKM-10-001	CKM-10-011	CKM-10-002	CKM-10-012
CKM-10-003	CKM-10-013	CKM-10-004	CKM-10-014
CKM-10-005	CKM-10-015	CKM-10-006	CKM-10-016
CKM-10-007	CKM-10-017		



Barrier System

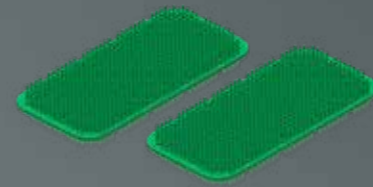

Silicone Mat
CSC-27-012 270 x 125 mm

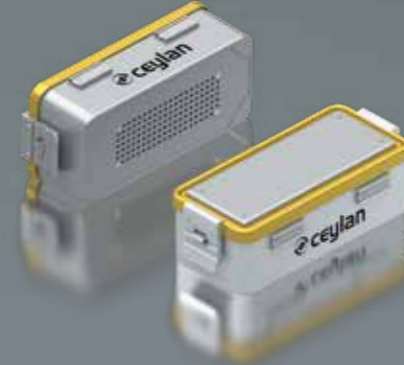

Bottom Non Perforated Bottom Perforated

300x140x100mm		300x140x100mm	
CKM-B-10-001	CKM-B-10-011	CKM-B-10-002	CKM-B-10-012
CKM-B-10-003	CKM-B-10-013	CKM-B-10-004	CKM-B-10-014
CKM-B-10-005	CKM-B-10-015	CKM-B-10-006	CKM-B-10-016
CKM-B-10-007	CKM-B-10-017		

Bottom Non Perforated Bottom Perforated

300x140x70mm		300x140x70mm	
CKM-B-07-001	CKM-B-07-011	CKM-B-07-002	CKM-B-07-012
CKM-B-07-003	CKM-B-07-013	CKM-B-07-004	CKM-B-07-014
CKM-B-07-005	CKM-B-07-015	CKM-B-07-006	CKM-B-07-016
CKM-B-07-007	CKM-B-07-017		

Bottom Non Perforated Bottom Perforated

300x140x40mm		300x140x40mm	
CKM-B-04-001	CKM-B-04-011	CKM-B-04-002	CKM-B-04-012
CKM-B-04-003	CKM-B-04-013	CKM-B-04-004	CKM-B-04-014
CKM-B-04-005	CKM-B-04-015	CKM-B-04-006	CKM-B-04-016
CKM-B-04-007	CKM-B-04-017		



Endoscopy Containers

Bottom Non Perforated Bottom Perforated

550x160x100mm		550x160x100mm	
■ CLS-10-001	■ CLS-10-011	■ CLS-10-001	■ CLS-10-011
■ CLS-10-002	■ CLS-10-012	■ CLS-10-002	■ CLS-10-012
■ CLS-10-003	■ CLS-10-013	■ CLS-10-003	■ CLS-10-013
■ CLS-10-004	■ CLS-10-014	■ CLS-10-004	■ CLS-10-014
■ CLS-10-005	■ CLS-10-015	■ CLS-10-005	■ CLS-10-015
■ CLS-10-006	■ CLS-10-016	■ CLS-10-006	■ CLS-10-016
■ CLS-10-007	■ CLS-10-017	■ CLS-10-007	■ CLS-10-017



Bottom Non Perforated Bottom Perforated

550x160x80mm		550x160x80mm	
■ CLS-08-001	■ CLS-08-011	■ CLS-08-001	■ CLS-08-011
■ CLS-08-002	■ CLS-08-012	■ CLS-08-002	■ CLS-08-012
■ CLS-08-003	■ CLS-08-013	■ CLS-08-003	■ CLS-08-013
■ CLS-08-004	■ CLS-08-014	■ CLS-08-004	■ CLS-08-014
■ CLS-08-005	■ CLS-08-015	■ CLS-08-005	■ CLS-08-015
■ CLS-08-006	■ CLS-08-016	■ CLS-08-006	■ CLS-08-016
■ CLS-08-007	■ CLS-08-017	■ CLS-08-007	■ CLS-08-017

Bottom Non Perforated Bottom Perforated

550x160x60mm		550x160x60mm	
■ CLS-06-001	■ CLS-06-011	■ CLS-06-001	■ CLS-06-011
■ CLS-06-002	■ CLS-06-012	■ CLS-06-002	■ CLS-06-012
■ CLS-06-003	■ CLS-06-013	■ CLS-06-003	■ CLS-06-013
■ CLS-06-004	■ CLS-06-014	■ CLS-06-004	■ CLS-06-014
■ CLS-06-005	■ CLS-06-015	■ CLS-06-005	■ CLS-06-015
■ CLS-06-006	■ CLS-06-016	■ CLS-06-006	■ CLS-06-016
■ CLS-06-007	■ CLS-06-017	■ CLS-06-007	■ CLS-06-017



Mini Containers



New Model

Bottom Non Perforated Bottom Perforated

310x140x100mm		310x140x100mm	
■ CKM-Y-10-001	■ CKM-Y-10-011	■ CKM-Y-10-001	■ CKM-Y-10-011
■ CKM-Y-10-002	■ CKM-Y-10-012	■ CKM-Y-10-002	■ CKM-Y-10-012
■ CKM-Y-10-003	■ CKM-Y-10-013	■ CKM-Y-10-003	■ CKM-Y-10-013
■ CKM-Y-10-004	■ CKM-Y-10-014	■ CKM-Y-10-004	■ CKM-Y-10-014
■ CKM-Y-10-005	■ CKM-Y-10-015	■ CKM-Y-10-005	■ CKM-Y-10-015
■ CKM-Y-10-006	■ CKM-Y-10-016	■ CKM-Y-10-006	■ CKM-Y-10-016
■ CKM-Y-10-007	■ CKM-Y-10-017	■ CKM-Y-10-007	■ CKM-Y-10-017



Bottom Non Perforated Bottom Perforated

310x140x70mm		310x140x70mm	
■ CKM-Y-07-001	■ CKM-Y-07-011	■ CKM-Y-07-001	■ CKM-Y-07-011
■ CKM-Y-07-002	■ CKM-Y-07-012	■ CKM-Y-07-002	■ CKM-Y-07-012
■ CKM-Y-07-003	■ CKM-Y-07-013	■ CKM-Y-07-003	■ CKM-Y-07-013
■ CKM-Y-07-004	■ CKM-Y-07-014	■ CKM-Y-07-004	■ CKM-Y-07-014
■ CKM-Y-07-005	■ CKM-Y-07-015	■ CKM-Y-07-005	■ CKM-Y-07-015
■ CKM-Y-07-006	■ CKM-Y-07-016	■ CKM-Y-07-006	■ CKM-Y-07-016
■ CKM-Y-07-007	■ CKM-Y-07-017	■ CKM-Y-07-007	■ CKM-Y-07-017

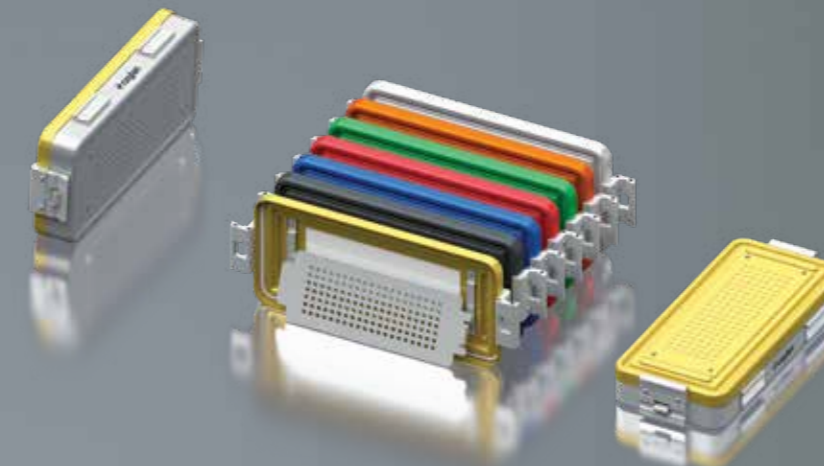
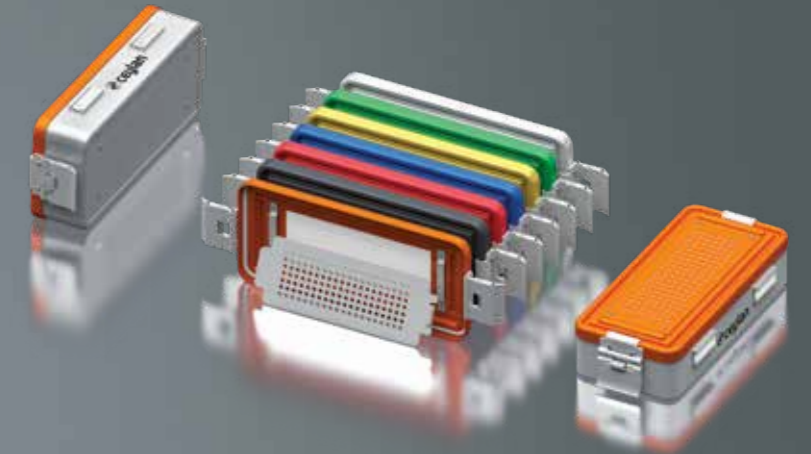

Bottom Non Perforated Bottom Perforated

310x140x40mm		310x140x40mm	
■ CKM-Y-04-001	■ CKM-Y-04-011	■ CKM-Y-04-001	■ CKM-Y-04-011
■ CKM-Y-04-002	■ CKM-Y-04-012	■ CKM-Y-04-002	■ CKM-Y-04-012
■ CKM-Y-04-003	■ CKM-Y-04-013	■ CKM-Y-04-003	■ CKM-Y-04-013
■ CKM-Y-04-004	■ CKM-Y-04-014	■ CKM-Y-04-004	■ CKM-Y-04-014
■ CKM-Y-04-005	■ CKM-Y-04-015	■ CKM-Y-04-005	■ CKM-Y-04-015
■ CKM-Y-04-006	■ CKM-Y-04-016	■ CKM-Y-04-006	■ CKM-Y-04-016
■ CKM-Y-04-007	■ CKM-Y-04-017	■ CKM-Y-04-007	■ CKM-Y-04-017



For Half Size

Code	Dimension
CTK-03-010	255x245x30mm
CTK-05-010	255x245x50mm
CTK-07-010	255x245x70mm
CTK-10-010	255x245x100mm

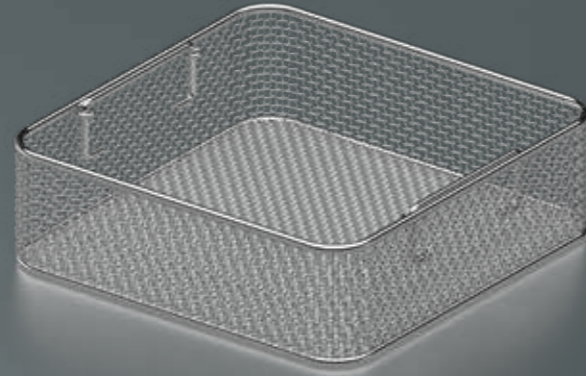

For Middle Size

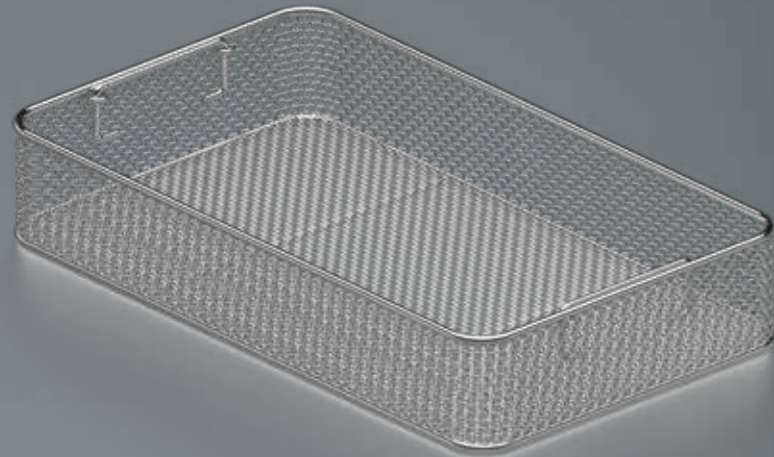

Code	Dimension
CTO-03-010	405x255x30mm
CTO-05-010	405x255x50mm
CTO-07-010	405x255x70mm
CTO-10-010	405x255x100mm

For Full Size

Code	Dimension
CTB-03-010	485x255x30mm
CTB-05-010	485x255x50mm
CTB-07-010	485x255x70mm
CTB-10-010	485x255x100mm

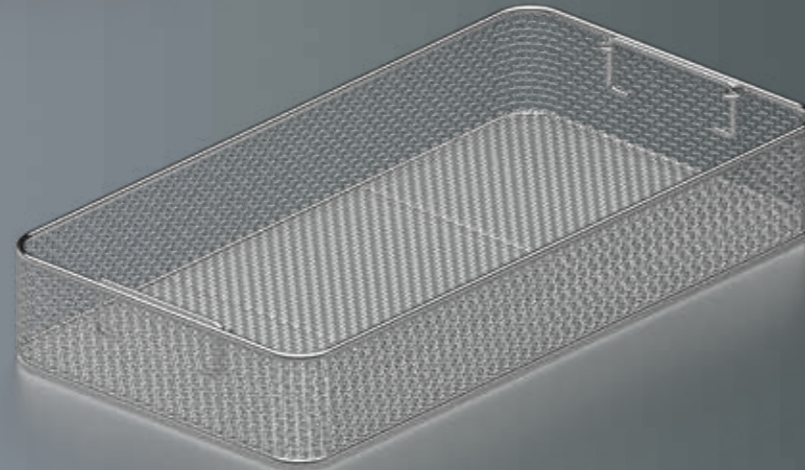

Wire Baskets



For Mini Containers

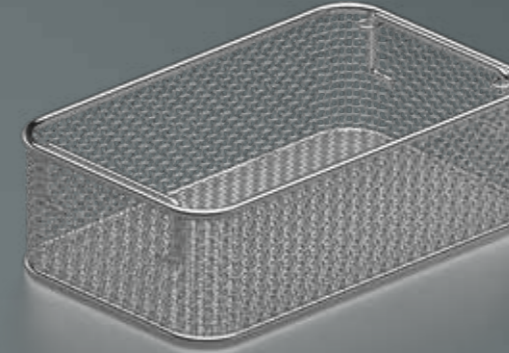

Code	Dimension
CTM-03-010	265x125x30mm
CTM-05-010	265x125x50mm
CTM-08-010	265x125x80mm

For Dental Containers

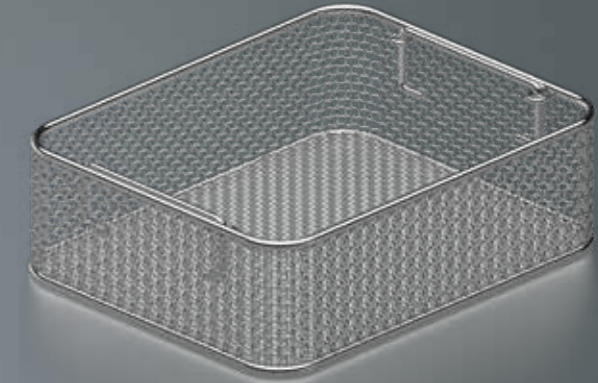

Code	Dimension
CTD-03-010	265x175x30mm
CTD-05-010	265x175x50mm
CTD-08-010	265x175x80mm

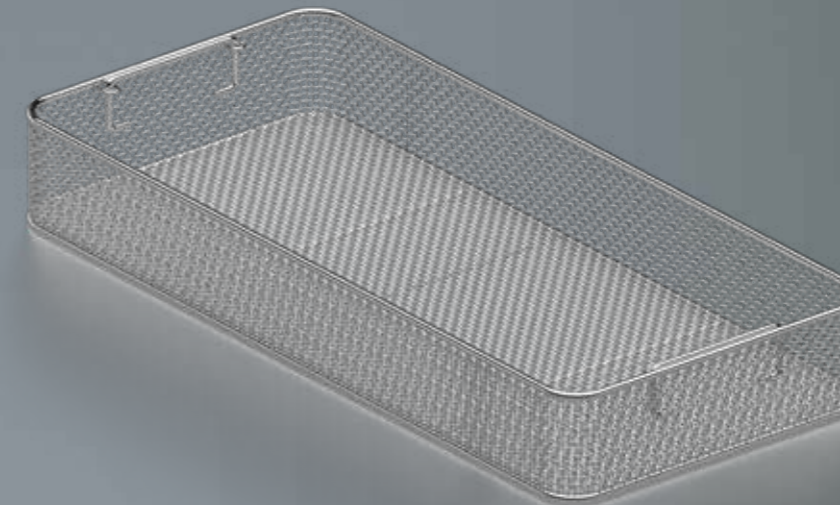

For Full Size

Code	Dimension
CTB-03-020	540x255x30mm
CTB-05-020	540x255x50mm
CTB-07-020	540x255x70mm
CTB-10-020	540x255x100mm

Stainless Steel Baskets



With Lid For Mini Size

Code	Dimension
CCSM-03-011	265x125x30mm
CCSM-05-011	265x125x50mm

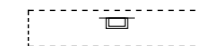

Without Lid For Mini Size

Code	Dimension
CCSM-03-010	265x125x30mm
CCSM-05-010	265x125x50mm

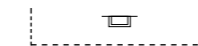

With Lid For Dental Size

Code	Dimension
CCSD-04-011	270x170x40mm
CCSD-05-011	270x170x50mm



Without Lid For Dental Size

Code	Dimension
CCSD-04-010	270x170x40mm
CCSD-05-010	270x170x50mm

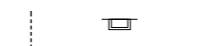

With Lid For Half Size

Code	Dimension
CCSK-03-011	255x245x30mm
CCSK-05-011	255x245x50mm
CCSK-07-011	255x245x70mm
CCSK-10-011	255x245x100mm

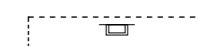

Without Lid For Half Size

Code	Dimension
CCSK-03-010	255x245x30mm
CCSK-05-010	255x245x50mm
CCSK-07-010	255x245x70mm
CCSK-10-010	255x245x100mm



With Lid For Middle Size

Code	Dimension
CCSO-03-011	405x255x30mm
CCSO-05-011	405x255x50mm
CCSO-07-011	405x255x70mm
CCSO-10-011	405x255x100mm

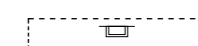

Without Lid For Middle Size

Code	Dimension
CCSO-03-010	405x255x30mm
CCSO-05-010	405x255x50mm
CCSO-07-010	405x255x70mm
CCSO-10-010	405x255x100mm



With Lid For Full Size

Code	Dimension
CCSB-03-011	485x255x30mm
CCSB-05-011	485x255x50mm
CCSB-07-011	485x255x70mm
CCSB-10-011	485x255x100mm

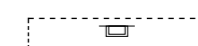

Without Lid For Full Size

Code	Dimension
CCSB-03-010	485x255x30mm
CCSB-05-010	485x255x50mm
CCSB-07-010	485x255x70mm
CCSB-10-010	485x255x100mm



With Lid Extra Large Size

Code	Dimension
CCSB-03-021	540x255x30mm
CCSB-05-021	540x255x50mm
CCSB-07-021	540x255x70mm
CCSB-10-021	540x255x100mm

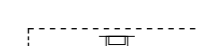

Without Lid Extra Large Size

Code	Dimension
CCSB-03-020	540x255x30mm
CCSB-05-020	540x255x50mm
CCSB-07-020	540x255x70mm
CCSB-10-020	540x255x100mm



CEB-10-001
Pack of 100
For Full, Middle and Half Size



CEB-20-001
Pack of 100
For Mini/Dental Containers

COLOUR LABEL
Coloured identification labels Printed to your specifications
(Maximum 16 letters)

- CER-10-001 Gynaecology
- CER-10-002 Spinal
- CER-10-003 E.N.T
- CER-10-004 General
- CER-10-005 Neurosurgery
- CER-10-006 Micro
- CER-10-007 Cardiovascular



CPM-10-010
Pack of 100
Plastic Security Seal

Silicone Stick Holder



CTF-01
20x250 mm
CTF-02
25x250 mm
CTF-03
40x250 mm



CFK-10-001
Pack of 100-Paper Filter
For Full, Middle and Half Size Containers



PTFE-001
Teflon Filter



CFB-10-001
Single Textile Filter
For Full, Middle and Half Size Containers



CFK-01
Round Filter Base



CFK-20-001
Pack of 100-Paper Filter
For Mini/Dental Containers



CFB-20-001
Single Textile
For Mini/Dental Containers

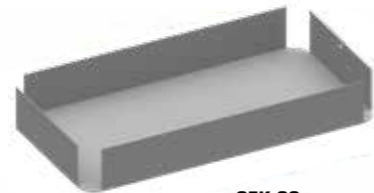

CFK-02
Dental and Mini Filter Base

Silicone Mats



CSC-24-023
245x245 mm

CSC-38-023
380x230 mm

CSC-44-023
440x230 mm

CSC-52-023
520x230 mm



CFT-18-001
Filter Holder
For Full, Middle and Half Size Containers



CM-01
50x20x12 mm



CM-02
50x20x20 mm

Stenter

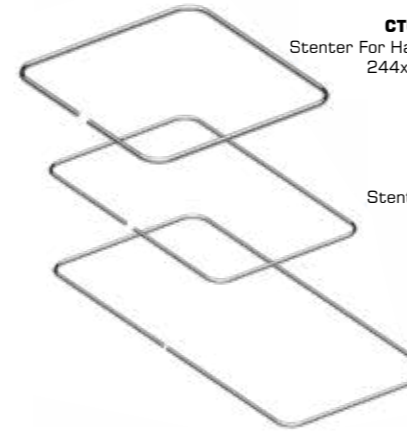

CTC-001
Stenter For Half Size Containers
244x255 mm

CTC-011
Stenter For Middle Size Containers
405x255 mm

CTC-110
Stenter For Full Size Containers
545x255 mm

CTC-002
Stenter For Half Size Containers
244x255x30 mm

CTC-012
Stenter For Middle Size Containers
405x255x30 mm

CTC-111
Stenter For Full Size Containers
545x255x30 mm

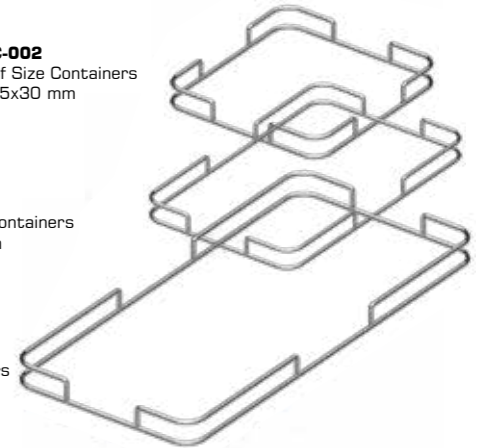

Wire Base

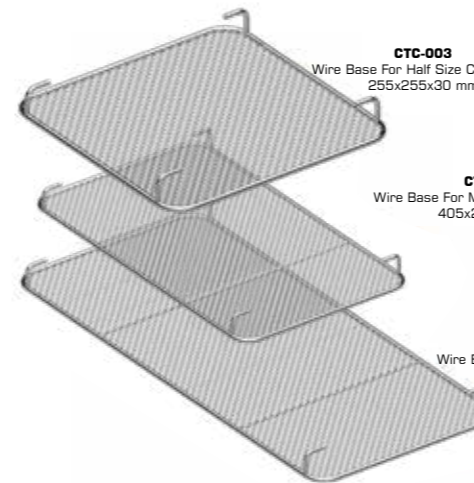

CTC-003
Wire Base For Half Size Containers
255x255x30 mm

CTC-013
Wire Base For Middle Size Containers
405x255x30 mm

CTC-112
Wire Base For Full Size Containers
545x255x30 mm

CTC-113 / CTC-114 / CTC-115 / CTC-116 / CTC-117
Dividers For Middle Size Containers
400x250x80 / 110 / 130 / 180 / 220 mm

CTC-004 / CTC-005 / CTC-006 / CTC-007 / CTC-008
Dividers For Half Size Containers
250x245x80 / 110 / 130 / 180 / 220 mm

CTC-014 / CTC-015 / CTC-016
Dividers For Middle Size Containers
400x250x90 / 110 / 130 mm

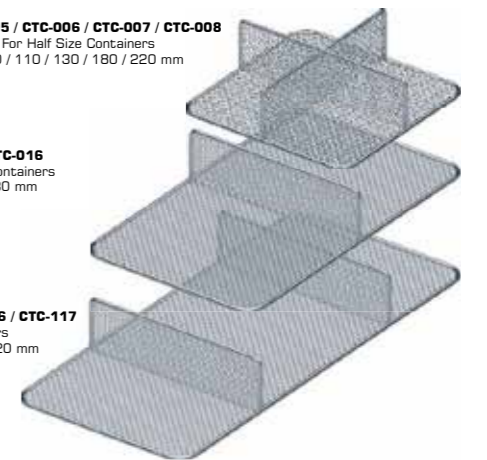

For Large Size



CTB-001
470x337x50 mm
CTB-002
470x337x100 mm
CTB-003
470x337x150 mm

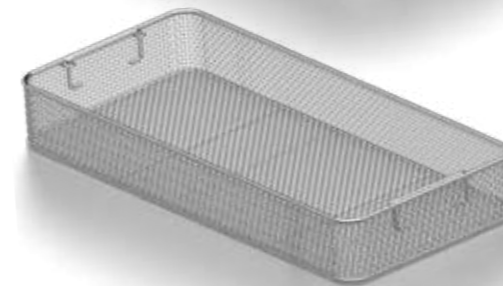

CTB-010
533x337x50 mm
CTB-012
533x337x100 mm
CTB-013
533x337x150 mm

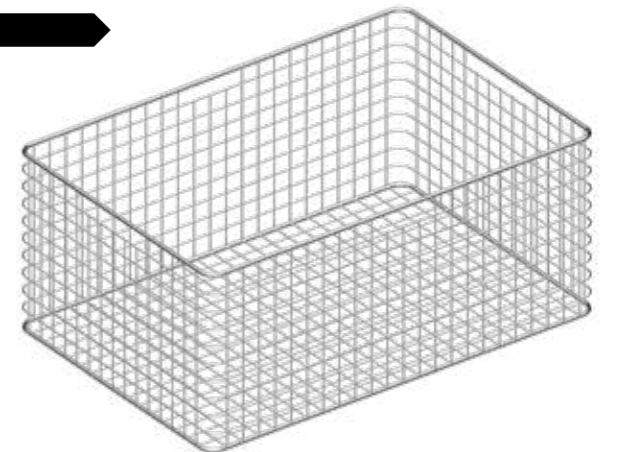

CTB-020 605x405x100 mm **CTB-021** 605x405x150 mm **CTB-022** 605x405x200 mm
CTB-023 605x405x250 mm **CTB-024** 605x405x300 mm

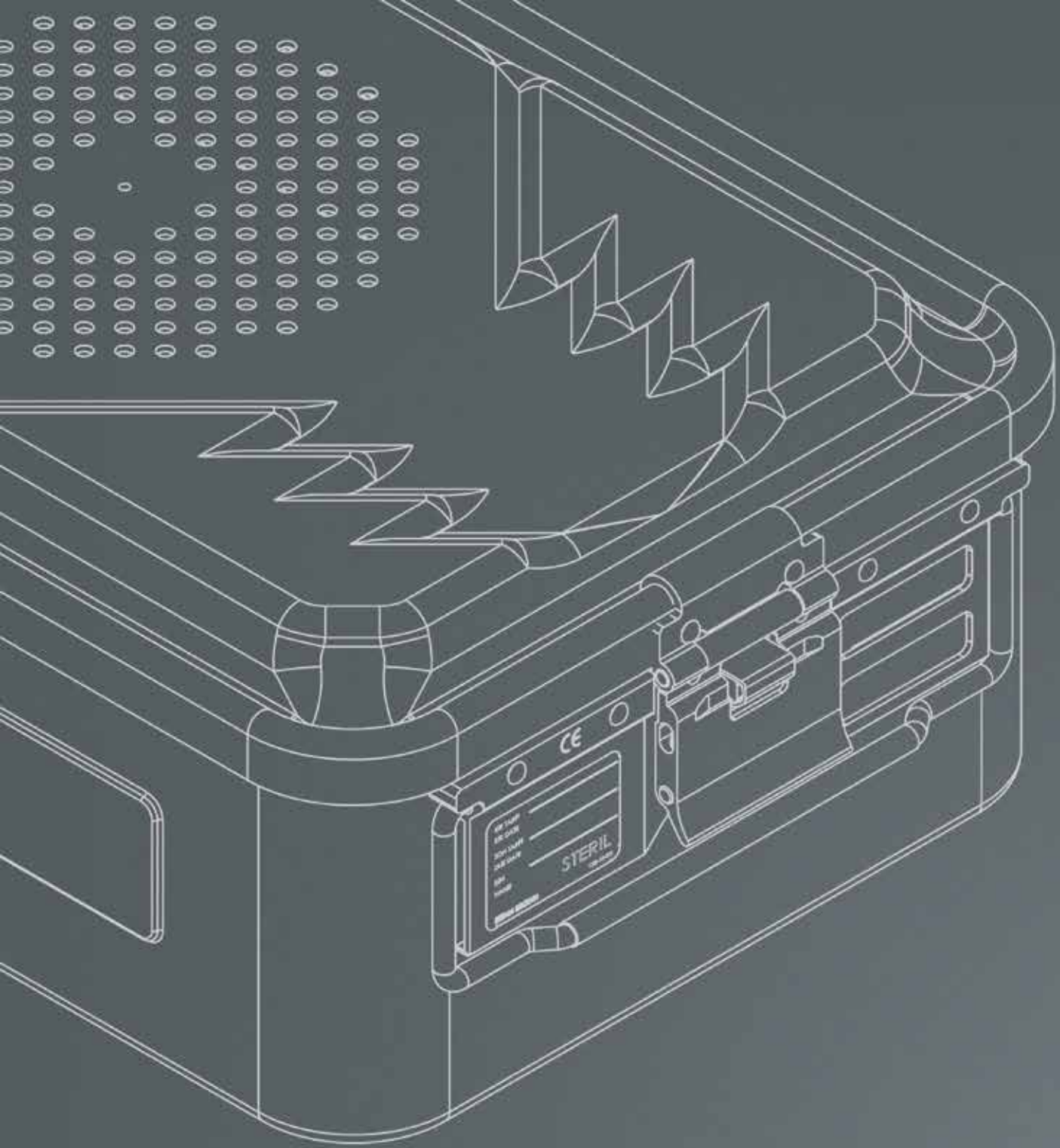

 **ceylan**

Yenicami OSB Mah. 5. Cad. No: 6/4 Kavak/SAMSUN/TÜRKİYE
Phone-Tel: +90 362 266 81 71 Fax-Faks: +90 362 266 81 72
info@ceylantibbi.com.tr • www.ceylantibbi.com.tr

